

Light efficiency:

34 Lumen/Watt

Light quality:

CRI: 0.0

Color temperature:

0 K

Output: 3298 lm

Peak: 19468 cd

Power: 98.3 W

PF: 1.0

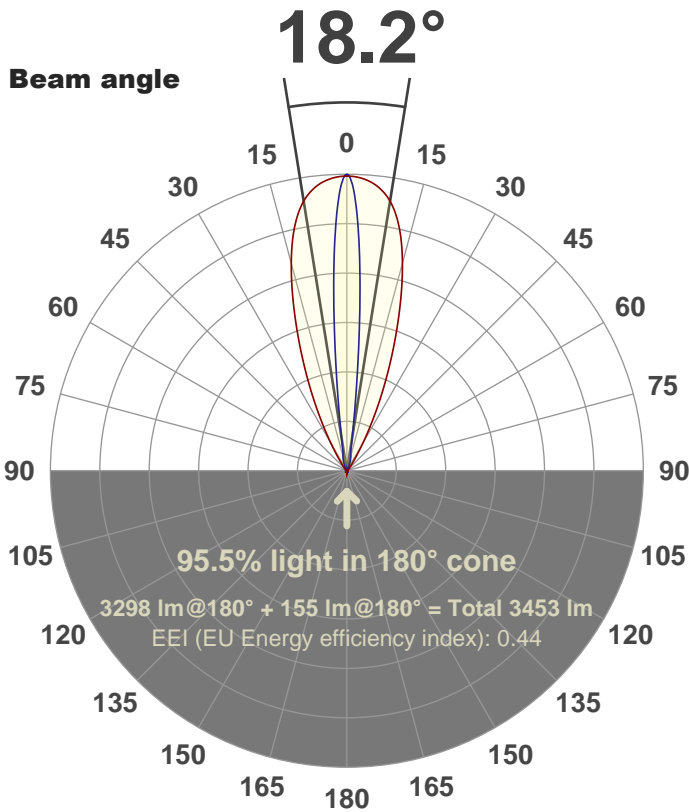

Product name:

FL100-CM-RGBW65K-IM-10X40-ELV-SM-GREEN

Date and time:

13-Jun-18 10:22:12 AM

Additional Information:

LED: RGBW

FIXTURE: FL100

FILM: 250232 (1°X40°)

COLOR-AMP: ON

STABILIZED: YES

COLOR (RGBW): GREEN

FWHM: 9.8°X39.3°

PERFORMED BY: ABDULLAH QURESHI

Color



CIE 1931

x: 0.158

y: 0.698

Spectra

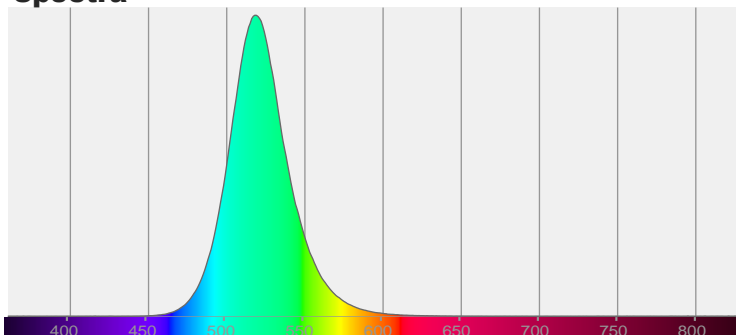

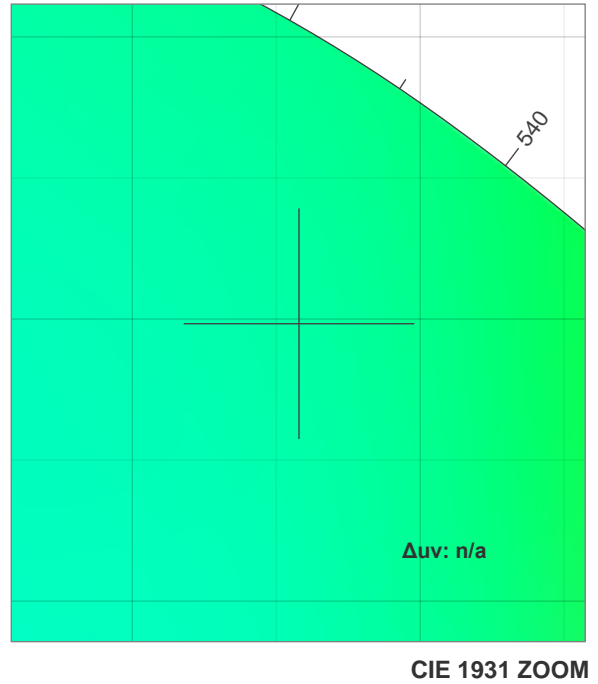
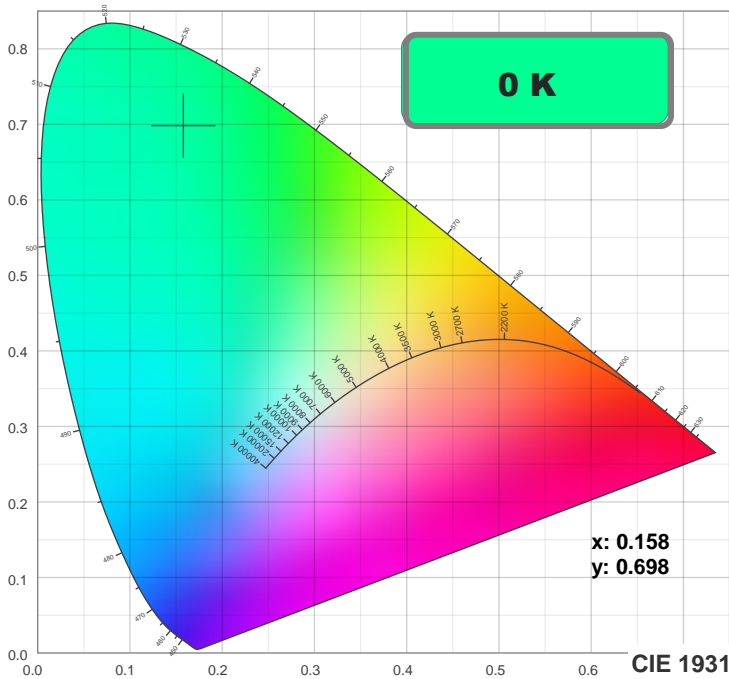

TM30: 0.0

CRI: 0.0 (R1-R8)

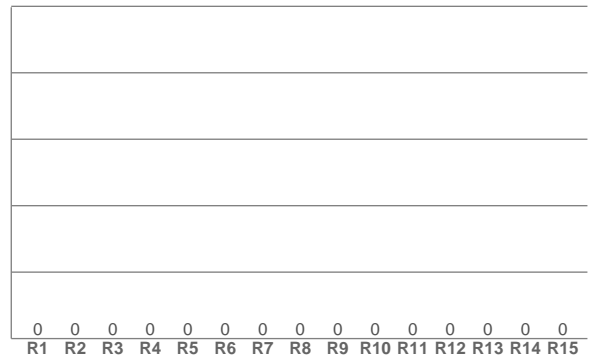
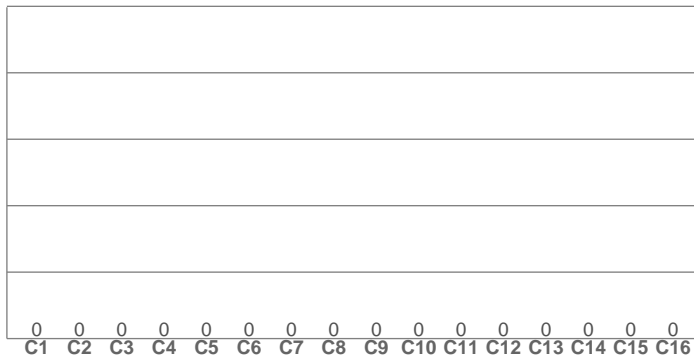

CRI R values, only R1-R8 are used to calculate final CRI value

R1	R2	R3	R4	R5	R6	R7	R8	R9	R10	R11	R12	R13	R14	R15
0.0	0.0	0.0	0.0	0.0	0.0	0.0	0.0	0.0	0.0	0.0	0.0	0.0	0.0	0.0

TM30 C values, 16 binned values out of total of 99 C values

C1	C2	C3	C4	C5	C6	C7	C8	C9	C10	C11	C12	C13	C14	C15	C16
0.0	0.0	0.0	0.0	0.0	0.0	0.0	0.0	0.0	0.0	0.0	0.0	0.0	0.0	0.0	0.0

CQS Q values

Q1	Q2	Q3	Q4	Q5	Q6	Q7	Q8	Q9	Q10	Q11	Q12	Q13	Q14	Q15
0.0	0.0	0.0	0.0	0.0	0.0	0.0	0.0	0.0	0.0	0.0	0.0	0.0	0.0	0.0

CQS: 0.0

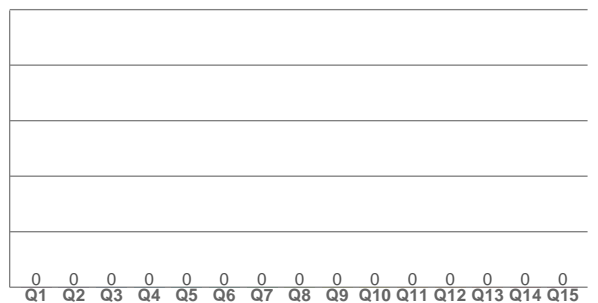

Color parameters

Color temperature	Color rendering index	Red component	Color fidelity	Color gamut	Color quality scale	Color coordinate cie 1931	Color coordinate cie 1931	Color coordinate	Color coordinate	Color deviation from black body
CCT	CRI	CRI R9	TM30 Rf	TM30 Rg	CQS	x	y	u	v	Δuv
0 K	0.0	0.0	0.0	0.0	0.0	0.158	0.698	0.057	0.379	n/a

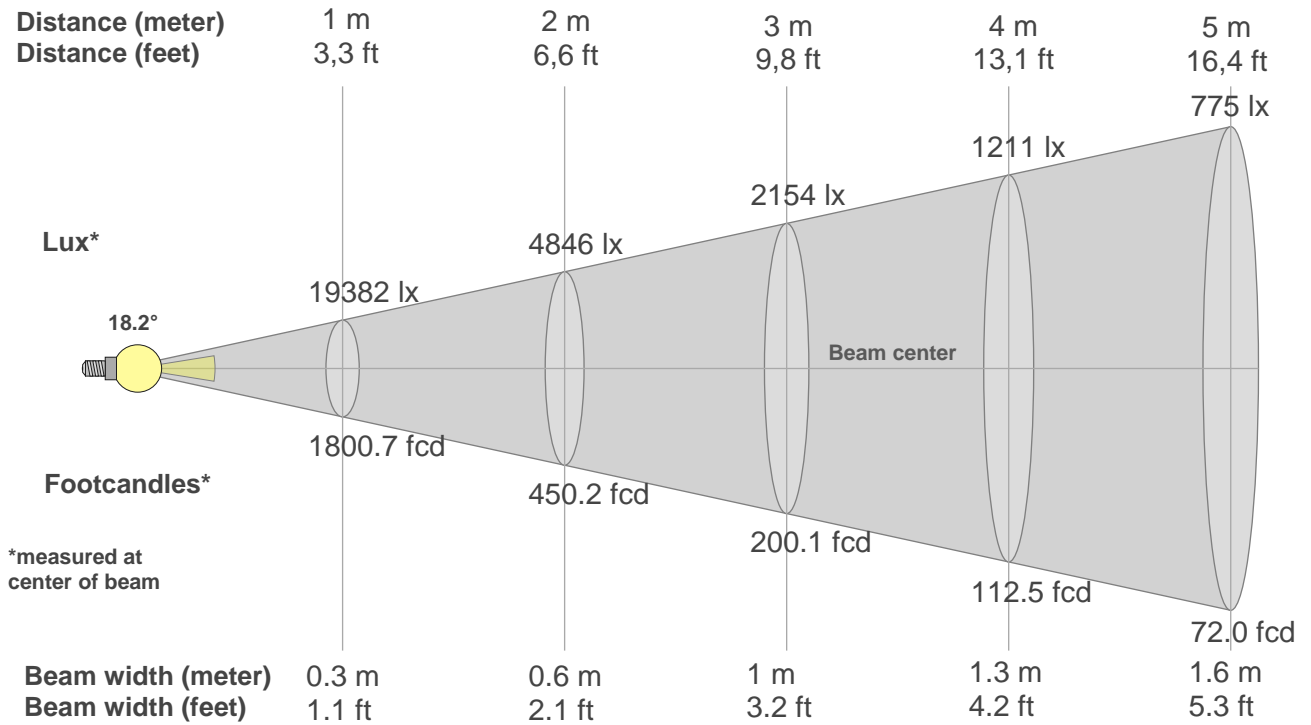

Beam intensities from 1-20m

1m	2m	3m	4m	5m	6m	7m	8m	9m	10m	11m	12m	13m	14m	15m	16m	17m	18m	19m	20m
3.3ft	6.6ft	9.8ft	13.1ft	16.4ft	19.7ft	23ft	26.2ft	29.5ft	32.8ft	36.1ft	39.4ft	42.7ft	45.9ft	49.2ft	52.5ft	55.8ft	59.1ft	62.3ft	65.6ft
19382lx	4846lx	2154lx	1211lx	775lx	538lx	396lx	303lx	239lx	194lx	160lx	135lx	115lx	99lx	86lx	76lx	67lx	60lx	54lx	48lx
1800.7fcd	450.2fcd	200.1fcd	112.5fcd	72fcd	50fcd	36.7fcd	28.1fcd	22.2fcd	18fcd	14.9fcd	12.5fcd	10.7fcd	9.2fcd	8fcd	7fcd	6.2fcd	5.6fcd	5fcd	4.5fcd

Intensities in 0° c-plane

0°	1°	2°	3°	4°	5°	6°	7°	8°	9°	10°	11°	12°	13°	14°	15°	16°	17°	18°	19°
19.4K	19.5K	19.4K	19.3K	19.2K	19.1K	18.9K	18.7K	18.4K	18.1K	17.6K	17.1K	16.5K	15.8K	15.0K	14.2K	13.3K	12.3K	11.3K	10.4K
100%	100%	100%	100%	99%	99%	98%	96%	95%	93%	91%	88%	85%	82%	78%	73%	68%	64%	58%	53%

Intensities in 90° c-plane

0°	1°	2°	3°	4°	5°	6°	7°	8°	9°	10°	11°	12°	13°	14°	15°	16°	17°	18°	19°
19.4K	18.9K	17.4K	15.2K	12.4K	9.5K	6.8K	4.7K	3.3K	2.3K	1.7K	1.4K	1.2K	1.1K	1.1K	1.0K	0.9K	0.9K	0.8K	0.7K
100%	98%	90%	78%	64%	49%	35%	24%	17%	12%	9%	7%	6%	6%	5%	5%	5%	4%	4%	4%

Intensities in 180° c-plane

0°	1°	2°	3°	4°	5°	6°	7°	8°	9°	10°	11°	12°	13°	14°	15°	16°	17°	18°	19°
19.4K	19.5K	19.4K	19.3K	19.2K	19.1K	18.9K	18.7K	18.4K	18.1K	17.6K	17.1K	16.5K	15.8K	15.0K	14.2K	13.3K	12.3K	11.3K	10.4K
100%	100%	100%	100%	99%	99%	98%	96%	95%	93%	91%	88%	85%	82%	78%	73%	68%	64%	58%	53%

Intensities in 270° c-plane

0°	1°	2°	3°	4°	5°	6°	7°	8°	9°	10°	11°	12°	13°	14°	15°	16°	17°	18°	19°
19.4K	18.9K	17.4K	15.2K	12.4K	9.5K	6.8K	4.7K	3.3K	2.3K	1.7K	1.4K	1.2K	1.1K	1.1K	1.0K	0.9K	0.9K	0.8K	0.7K
100%	98%	90%	78%	64%	49%	35%	24%	17%	12%	9%	7%	6%	6%	5%	5%	5%	4%	4%	4%

Beam angle 50%	Field angle 10%	Cutoff angle 2,5%	Intensity ratio in 120° cone	Intensity ratio in 90° cone
18.2°	32.3°	56.3°	90.7%	87.3%