



Light efficiency:



Light quality:



Color temperature:



Output: 5200 lm

Peak: 8208 cd

Power: 104 W

48.0V @ 2.18A



Product name:

**PH-FL100-RGBW40K-OM-ALL  
ON-40-ELV-21.03.17**

Date and time:

**3/21/2017 3:34:50 PM**

Additional information:

**BEAM ANGLE: 40°**

**10% Beam Angle: 79.6°**

Beam angle

**39.8°**

6 PLANES

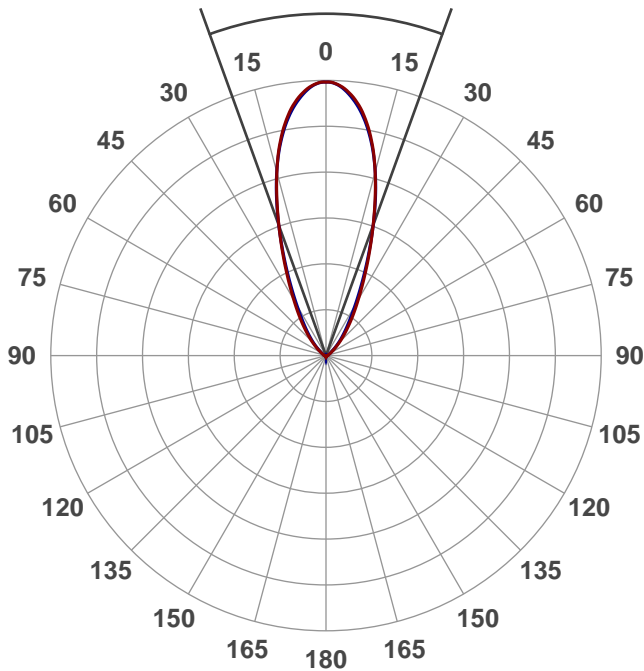

Color



CIE1931  
x: 0.278  
y: 0.247

Spectra

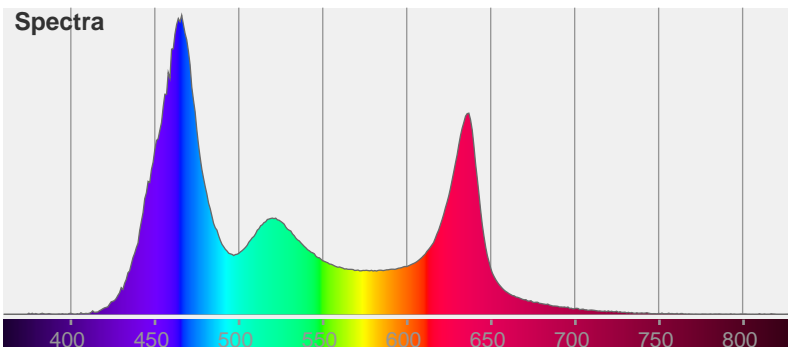

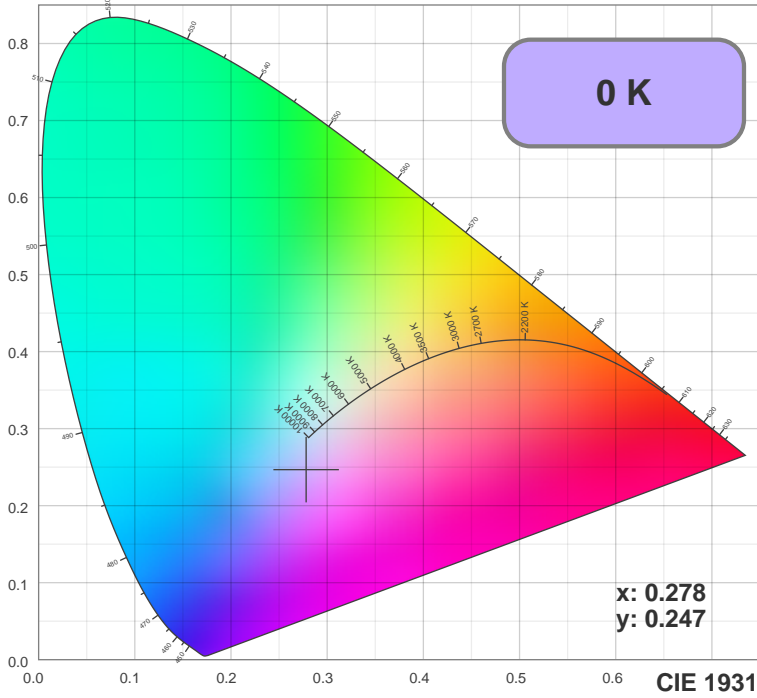

TM30: 0.0

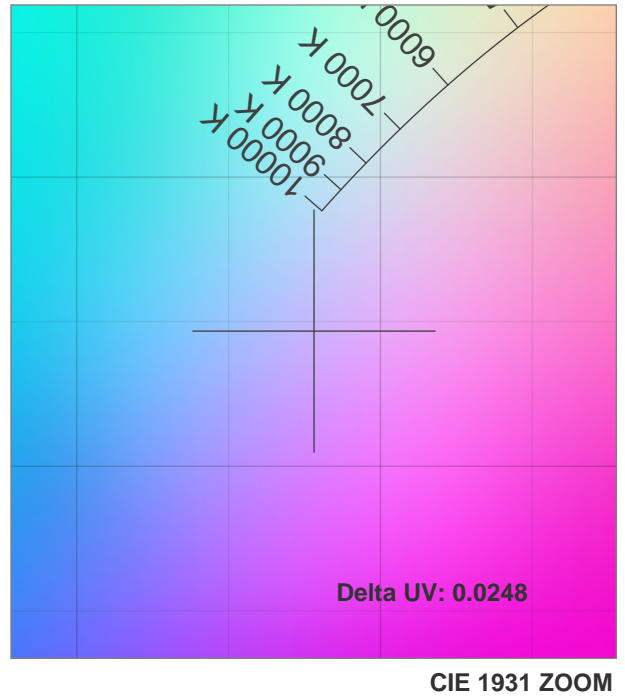
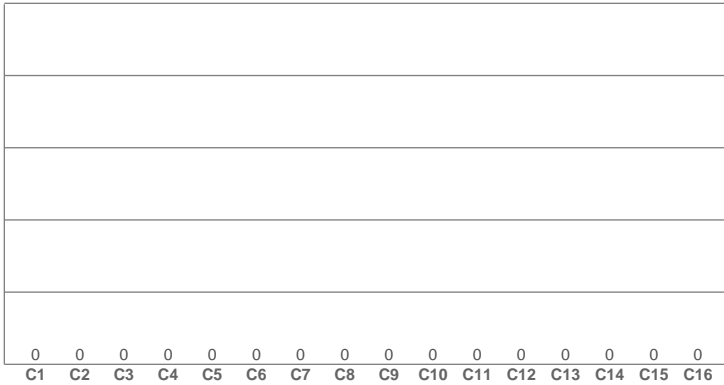

CIE 1931 ZOOM

CRI: 0.0 (R1-R8)

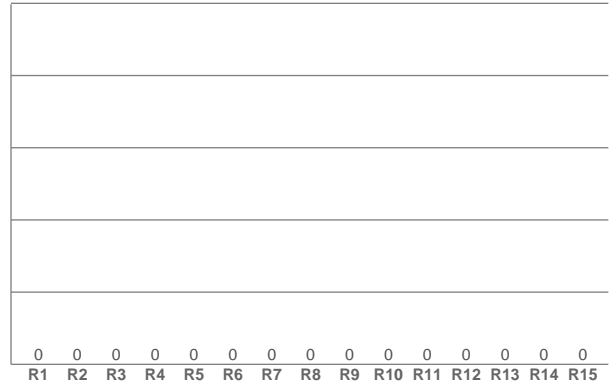

CQS: 0.0

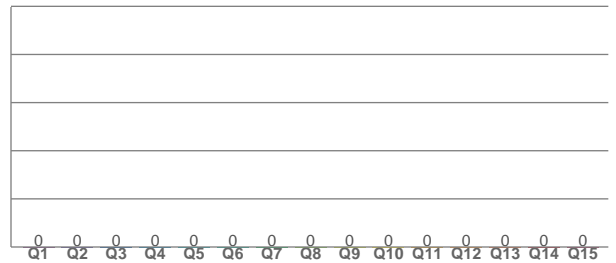

CRI R values, only R1-R8 are used to calculate final CRI value

R1	R2	R3	R4	R5	R6	R7	R8	R9	R10	R11	R12	R13	R14	R15
0.00	0.00	0.00	0.00	0.00	0.00	0.00	0.00	0.00	0.00	0.00	0.00	0.00	0.00	0.00

TM30 C values, 16 binned values out of total of 99 C values

C1	C2	C3	C4	C5	C6	C7	C8	C9	C10	C11	C12	C13	C14	C15	C16
0.00	0.00	0.00	0.00	0.00	0.00	0.00	0.00	0.00	0.00	0.00	0.00	0.00	0.00	0.00	0.00

CQS Q values

Q1	Q2	Q3	Q4	Q5	Q6	Q7	Q8	Q9	Q10	Q11	Q12	Q13	Q14	Q15
0.00	0.00	0.00	0.00	0.00	0.00	0.00	0.00	0.00	0.00	0.00	0.00	0.00	0.00	0.00

Color parameters

CCT	CRI	CRI R9	TM30 Rf	TM30 Rg	CQS	x	y	u	v	Duv
0 K	0.0	0.0	0.0	0.0	0.0	0.3	0.2	0.2	0.3	NaN

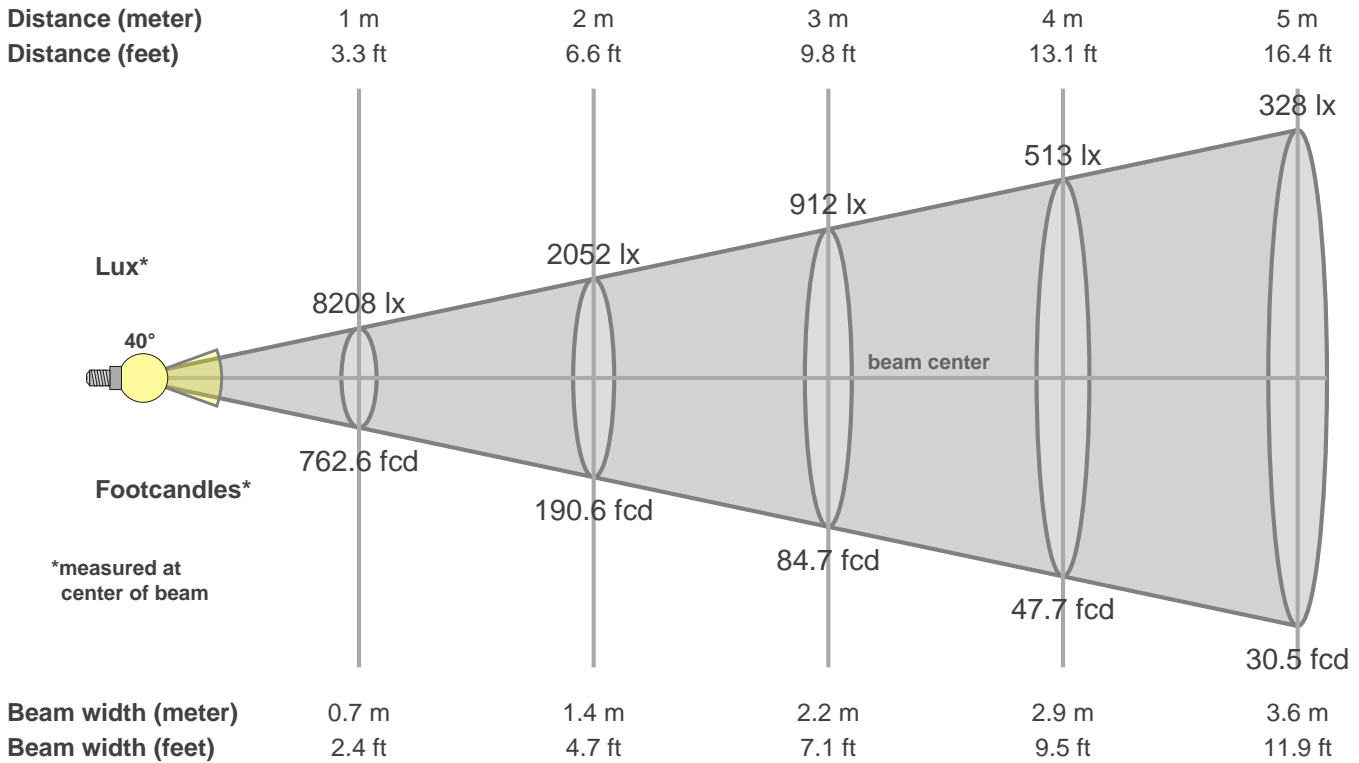

**Intensities in 0° c-plane**

0°	2°	4°	6°	8°	10°	12°	14°	16°	18°	20°	22°	24°	26°	28°	30°	32°	34°	36°	38°
8208	8163	8024	7795	7484	7069	6576	6006	5375	4734	4122	3565	3068	2626	2250	1929	1663	1432	1225	1044
100%	99%	98%	95%	91%	86%	80%	73%	65%	58%	50%	43%	37%	32%	27%	24%	20%	17%	15%	13%

**Intensities in 90° c-plane**

0°	2°	4°	6°	8°	10°	12°	14°	16°	18°	20°	22°	24°	26°	28°	30°	32°	34°	36°	38°
8208	8155	7989	7732	7410	7009	6534	5994	5400	4769	4130	3522	2973	2492	2089	1749	1470	1247	1064	909
100%	99%	97%	94%	90%	85%	80%	73%	66%	58%	50%	43%	36%	30%	25%	21%	18%	15%	13%	11%

**Intensities in 180° c-plane**

0°	2°	4°	6°	8°	10°	12°	14°	16°	18°	20°	22°	24°	26°	28°	30°	32°	34°	36°	38°
8208	8163	8024	7795	7484	7069	6576	6006	5375	4734	4122	3565	3068	2626	2250	1929	1663	1432	1225	1044
100%	99%	98%	95%	91%	86%	80%	73%	65%	58%	50%	43%	37%	32%	27%	24%	20%	17%	15%	13%

**Intensities in 270° c-plane**

0°	2°	4°	6°	8°	10°	12°	14°	16°	18°	20°	22°	24°	26°	28°	30°	32°	34°	36°	38°
8208	8155	7989	7732	7410	7009	6534	5994	5400	4769	4130	3522	2973	2492	2089	1749	1470	1247	1064	909
100%	99%	97%	94%	90%	85%	80%	73%	66%	58%	50%	43%	36%	30%	25%	21%	18%	15%	13%	11%

Beam angle 50%	Field angle 10%	Cutoff angle 2.5%	Intensity ratio in 120° cone	Intensity ratio in 90° cone
39.8°	79.6°	111.4°	94.6%	87.4%