



Light efficiency:



Light quality:



Color temperature:

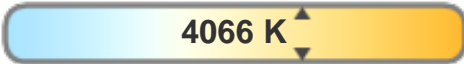

Output: 2528 lm
Peak: 47325 cd

Power: 32.8 W
48.0V @ 0.683A



Product name:
PH-FL100-RGBW40K-OM-WHITE-10-ELV

Date and time:
3/22/2017 12:16:29 PM

Additional information:
BEAM ANGLE: 10°
10% beam angle: 21.3°

Beam angle

10.9°

6 PLANES

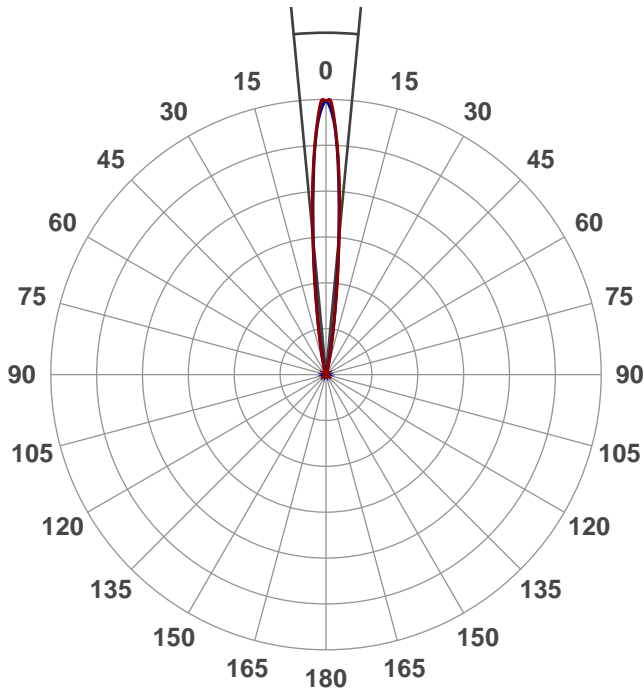

Color



CIE1931
x: 0.379
y: 0.379

Spectra

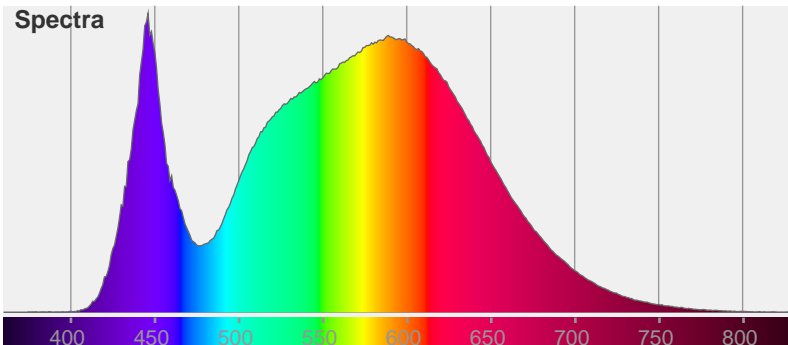

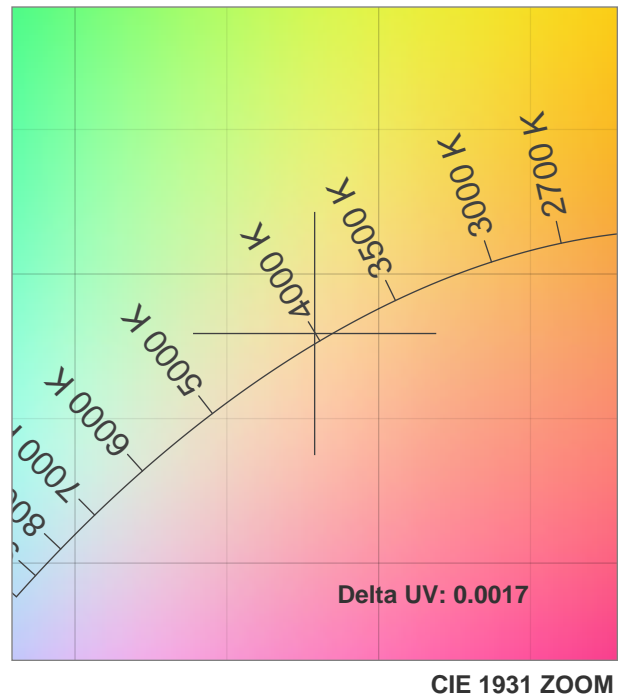
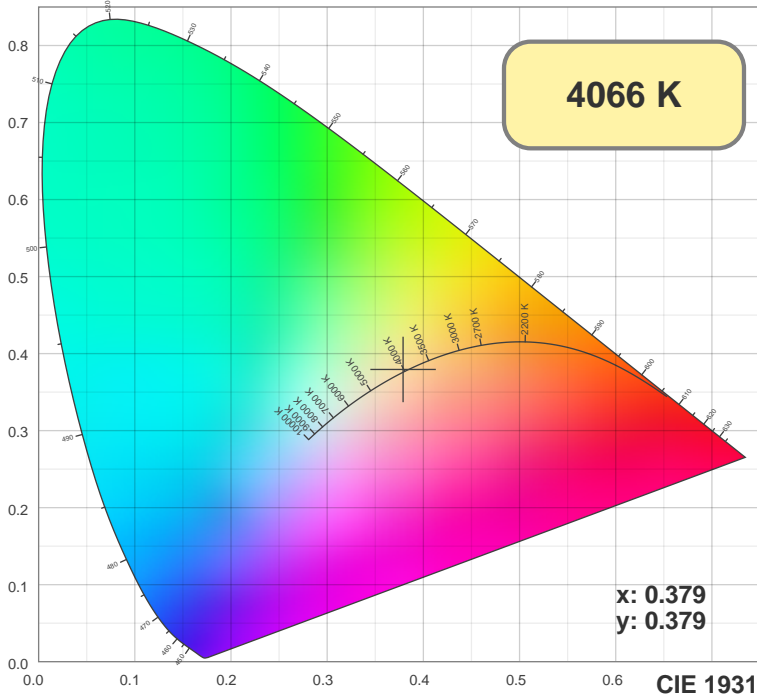

TM30: 81.1

CRI: 81.5 (R1-R8)

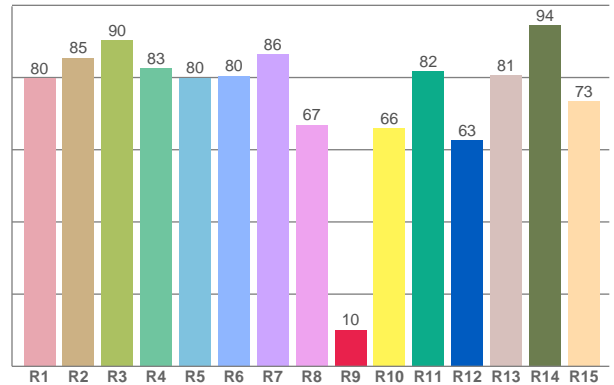
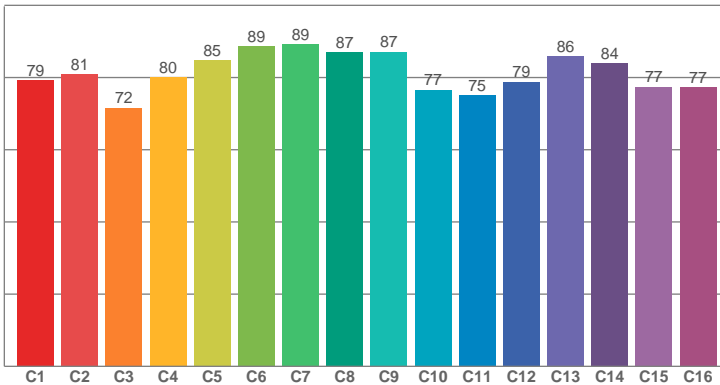

CRI R values, only R1-R8 are used to calculate final CRI value

R1	R2	R3	R4	R5	R6	R7	R8	R9	R10	R11	R12	R13	R14	R15
79.83	85.42	90.32	82.51	79.89	80.49	86.50	66.93	10.11	65.91	81.64	62.54	80.66	94.45	73.37

TM30 C values, 16 binned values out of total of 99 C values

C1	C2	C3	C4	C5	C6	C7	C8	C9	C10	C11	C12	C13	C14	C15	C16
79.16	80.85	71.61	79.99	84.81	88.59	89.14	86.96	87.12	76.57	75.02	78.79	85.80	83.87	77.44	77.21

CQS Q values

Q1	Q2	Q3	Q4	Q5	Q6	Q7	Q8	Q9	Q10	Q11	Q12	Q13	Q14	Q15
81.49	97.46	77.71	76.86	81.65	82.01	83.65	88.95	96.18	85.27	83.08	82.69	83.00	71.83	75.32

CQS: 81.9

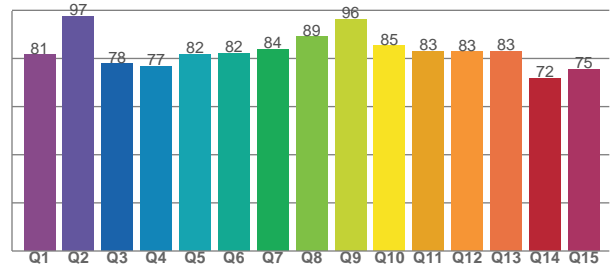

Color parameters

CCT	CRI	CRI R9	TM30 Rf	TM30 Rg	CQS	x	y	u	v	Duv
4066 K	81.5	10.1	81.1	97.7	81.9	0.4	0.4	0.2	0.3	0.0017

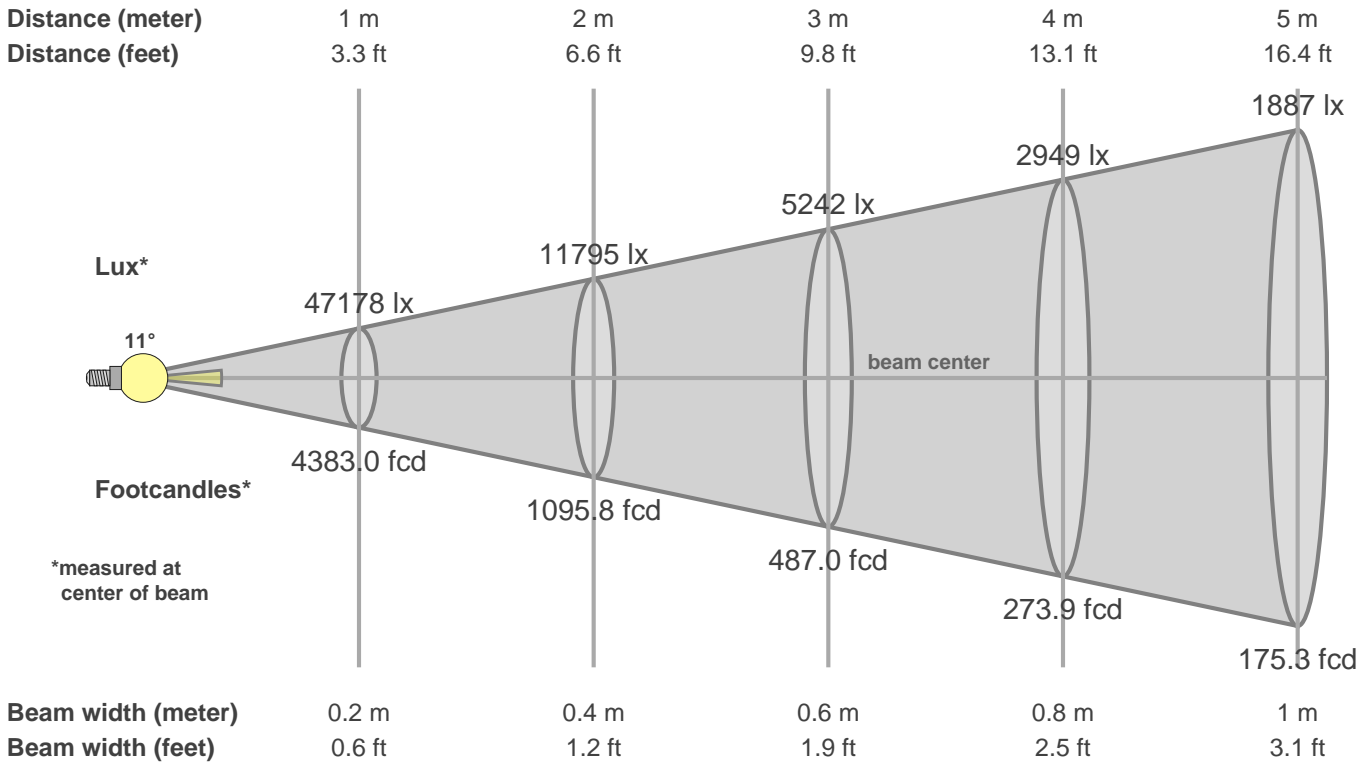

Intensities in 0° c-plane

0°	1°	2°	3°	4°	5°	6°	7°	8°	9°	10°	11°	12°	13°	14°	15°	16°	17°	18°	19°
47.2K	47.0K	43.3K	38.4K	32.8K	26.5K	20.5K	15.7K	11.4K	8.1K	6.0K	4.1K	3.1K	2.3K	1.7K	1.4K	1.1K	0.9K	0.7K	0.6K
100%	100%	92%	81%	69%	56%	43%	33%	24%	17%	13%	9%	7%	5%	4%	3%	2%	2%	2%	1%

Intensities in 90° c-plane

0°	1°	2°	3°	4°	5°	6°	7°	8°	9°	10°	11°	12°	13°	14°	15°	16°	17°	18°	19°
47.2K	45.7K	42.8K	38.0K	31.8K	25.7K	20.1K	14.8K	10.9K	8.0K	5.5K	4.1K	2.9K	2.2K	1.7K	1.3K	1.0K	0.8K	0.7K	0.6K
100%	97%	91%	81%	67%	54%	43%	31%	23%	17%	12%	9%	6%	5%	4%	3%	2%	2%	1%	1%

Intensities in 180° c-plane

0°	1°	2°	3°	4°	5°	6°	7°	8°	9°	10°	11°	12°	13°	14°	15°	16°	17°	18°	19°
47.2K	47.0K	43.3K	38.4K	32.8K	26.5K	20.5K	15.7K	11.4K	8.1K	6.0K	4.1K	3.1K	2.3K	1.7K	1.4K	1.1K	0.9K	0.7K	0.6K
100%	100%	92%	81%	69%	56%	43%	33%	24%	17%	13%	9%	7%	5%	4%	3%	2%	2%	2%	1%

Intensities in 270° c-plane

0°	1°	2°	3°	4°	5°	6°	7°	8°	9°	10°	11°	12°	13°	14°	15°	16°	17°	18°	19°
47.2K	45.7K	42.8K	38.0K	31.8K	25.7K	20.1K	14.8K	10.9K	8.0K	5.5K	4.1K	2.9K	2.2K	1.7K	1.3K	1.0K	0.8K	0.7K	0.6K
100%	97%	91%	81%	67%	54%	43%	31%	23%	17%	12%	9%	6%	5%	4%	3%	2%	2%	1%	1%

Beam angle 50%	Field angle 10%	Cutoff angle 2.5%	Intensity ratio in 120° cone	Intensity ratio in 90° cone
10.9°	21.3°	31.2°	98.1%	96.7%