

Light efficiency:



Light quality:



Color temperature:



Output: 428 lm

Peak: 645 cd

Power: 24.8 W

PF: 1.0



43.1°

Beam angle

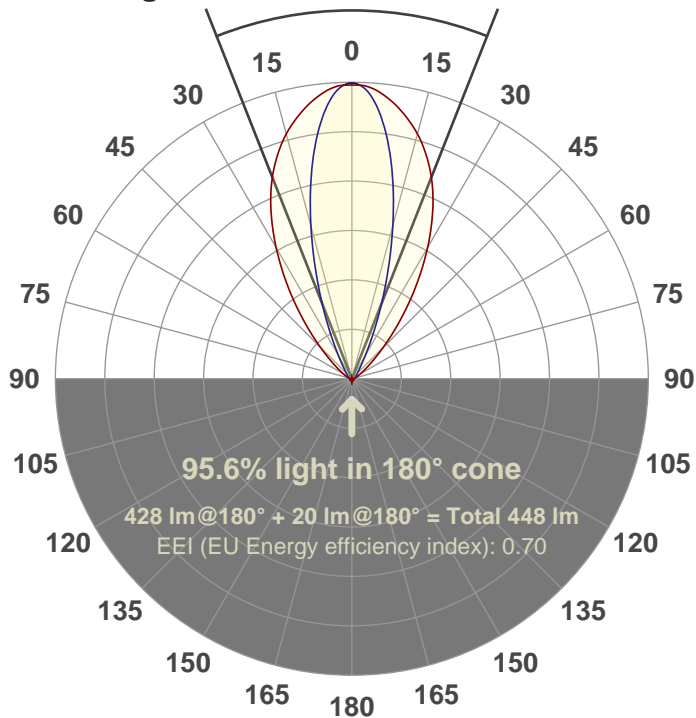

Product name:

FL25-CM-RGBW65K-IM-30x60-ELV-SM120-RED

Date and time:

10-Aug-18 10:11:05 AM

Additional Information:

LED: RGBW (6500K)

FIXTURE: FL25

FILM: 250262 (30°X60°)

COLOR-AMP: ON

STABILIZED: YES

COLOR (RGBW): RED

FWHM: 31.7°X61.1°

PERFORMED BY: ABDULLAH QURESHI

Color



CIE 1931

x: 0.701

y: 0.297

Spectra

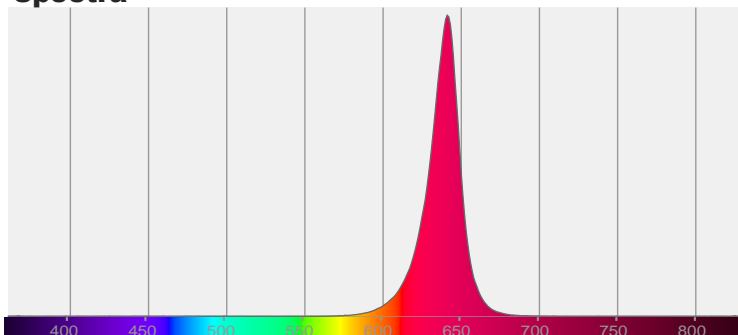

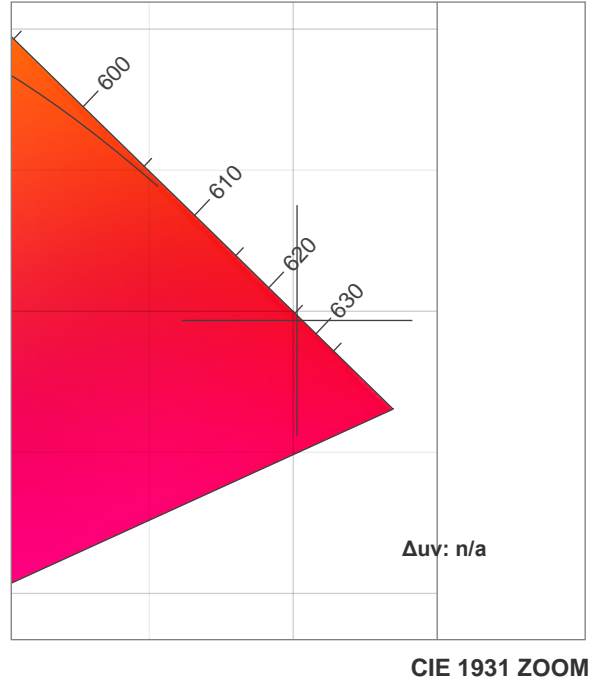
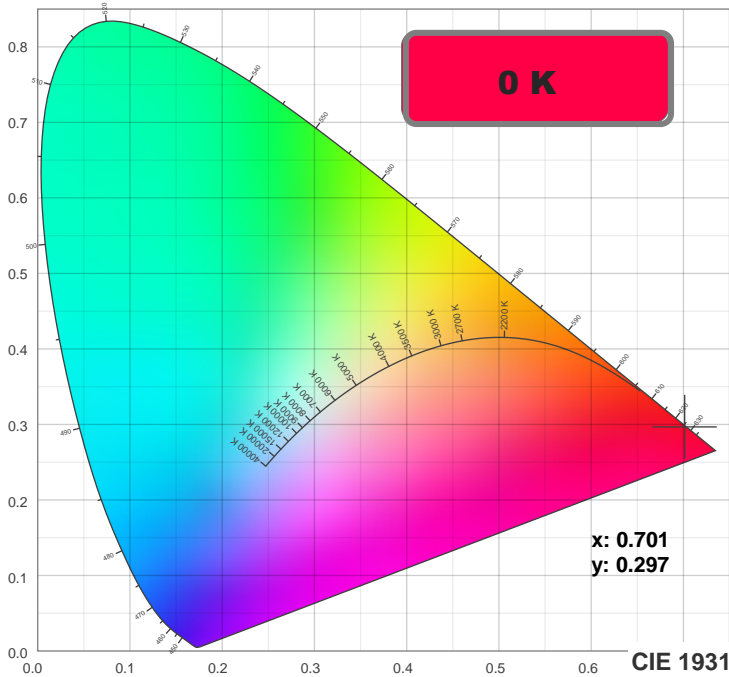

TM30: 0.0

CRI: 0.0 (R1-R8)

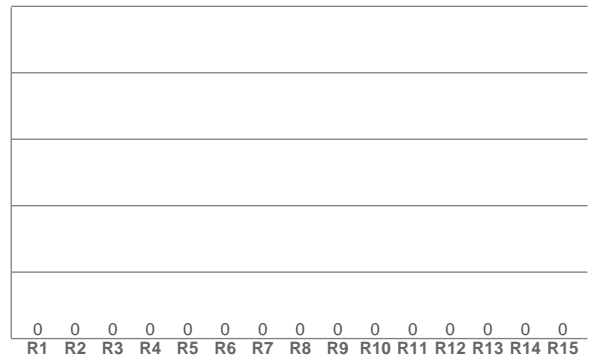

CRI R values, only R1-R8 are used to calculate final CRI value

R1	R2	R3	R4	R5	R6	R7	R8	R9	R10	R11	R12	R13	R14	R15
0.0	0.0	0.0	0.0	0.0	0.0	0.0	0.0	0.0	0.0	0.0	0.0	0.0	0.0	0.0

TM30 C values, 16 binned values out of total of 99 C values

C1	C2	C3	C4	C5	C6	C7	C8	C9	C10	C11	C12	C13	C14	C15	C16
0.0	0.0	0.0	0.0	0.0	0.0	0.0	0.0	0.0	0.0	0.0	0.0	0.0	0.0	0.0	0.0

CQS Q values

Q1	Q2	Q3	Q4	Q5	Q6	Q7	Q8	Q9	Q10	Q11	Q12	Q13	Q14	Q15
0.0	0.0	0.0	0.0	0.0	0.0	0.0	0.0	0.0	0.0	0.0	0.0	0.0	0.0	0.0

CQS: 0.0

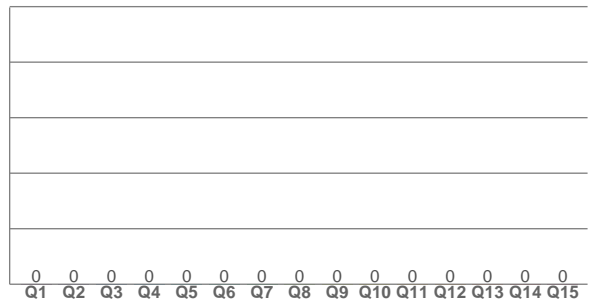

Color parameters

Color temperature	Color rendering index	Red component	Color fidelity	Color gamut	Color quality scale	Color coordinate cie 1931	Color coordinate cie 1931	Color coordinate	Color coordinate	Color deviation from black body
CCT	CRI	CRI R9	TM30 Rf	TM30 Rg	CQS	x	y	u	v	Δuv
0 K	0.0	0.0	0.0	0.0	0.0	0.701	0.297	0.544	0.345	n/a

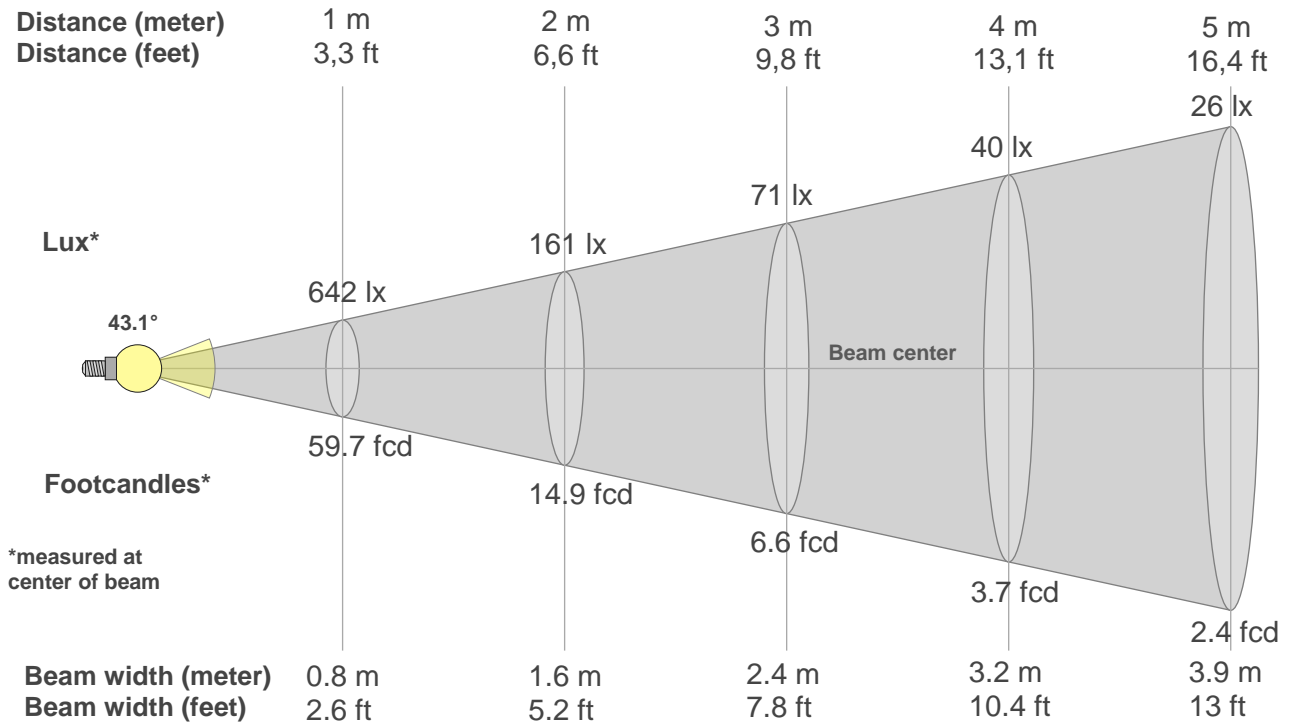

Beam intensities from 1-20m

1m	2m	3m	4m	5m	6m	7m	8m	9m	10m	11m	12m	13m	14m	15m	16m	17m	18m	19m	20m
3.3ft	6.6ft	9.8ft	13.1ft	16.4ft	19.7ft	23ft	26.2ft	29.5ft	32.8ft	36.1ft	39.4ft	42.7ft	45.9ft	49.2ft	52.5ft	55.8ft	59.1ft	62.3ft	65.6ft
642lx	161lx	71lx	40lx	26lx	18lx	13lx	10lx	8lx	6lx	5lx	4lx	4lx	3lx	3lx	3lx	2lx	2lx	2lx	2lx
59.7fcd	14.9fcd	6.6fcd	3.7fcd	2.4fcd	1.7fcd	1.2fcd	0.9fcd	0.7fcd	0.6fcd	0.5fcd	0.4fcd	0.4fcd	0.3fcd	0.3fcd	0.2fcd	0.2fcd	0.2fcd	0.2fcd	0.1fcd

Intensities in 0° c-plane

0°	2°	4°	6°	8°	10°	12°	14°	16°	18°	20°	22°	24°	26°	28°	30°	32°	34°	36°	38°
642	642	636	627	614	599	582	564	544	520	495	467	436	403	367	332	295	259	224	191
100%	100%	99%	98%	96%	93%	91%	88%	85%	81%	77%	73%	68%	63%	57%	52%	46%	40%	35%	30%

Intensities in 90° c-plane

0°	2°	4°	6°	8°	10°	12°	14°	16°	18°	20°	22°	24°	26°	28°	30°	32°	34°	36°	38°
642	638	617	583	540	489	433	375	318	263	213	168	130	100	77	60	47	38	32	27
100%	99%	96%	91%	84%	76%	67%	58%	49%	41%	33%	26%	20%	16%	12%	9%	7%	6%	5%	4%

Intensities in 180° c-plane

0°	2°	4°	6°	8°	10°	12°	14°	16°	18°	20°	22°	24°	26°	28°	30°	32°	34°	36°	38°
642	642	636	627	614	599	582	564	544	520	495	467	436	403	367	332	295	259	224	191
100%	100%	99%	98%	96%	93%	91%	88%	85%	81%	77%	73%	68%	63%	57%	52%	46%	40%	35%	30%

Intensities in 270° c-plane

0°	2°	4°	6°	8°	10°	12°	14°	16°	18°	20°	22°	24°	26°	28°	30°	32°	34°	36°	38°
642	638	617	583	540	489	433	375	318	263	213	168	130	100	77	60	47	38	32	27
100%	99%	96%	91%	84%	76%	67%	58%	49%	41%	33%	26%	20%	16%	12%	9%	7%	6%	5%	4%

Beam angle 50%	Field angle 10%	Cutoff angle 2,5%	Intensity ratio in 120° cone	Intensity ratio in 90° cone
43.1°	75.5°	109°	90.5%	83.7%