

Light efficiency:



Light quality:



Color temperature:



Output: 259 lm

Peak: 1411 cd

Power: 24.7 W

PF: 1.0

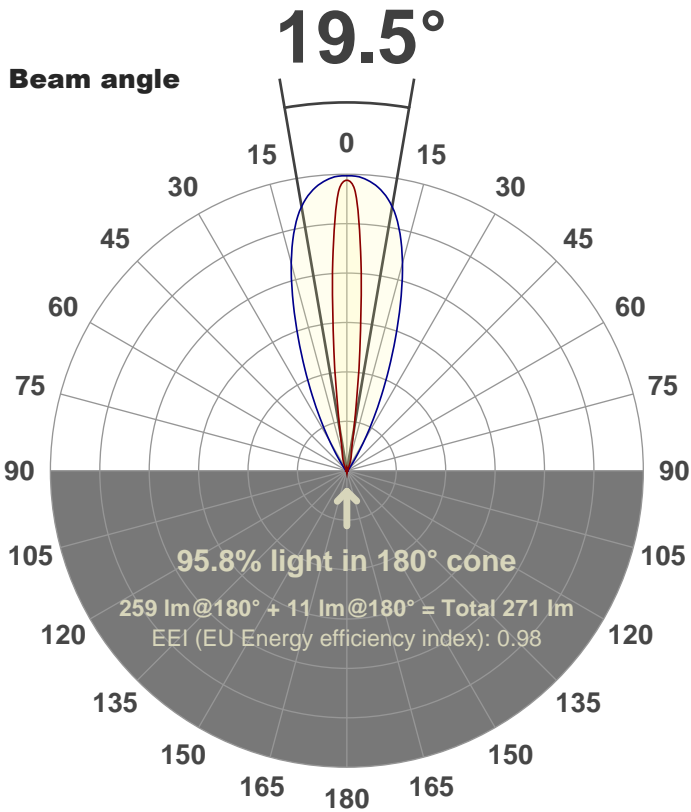

Product name:

FL25-CM-RGBW65K-IM-40X10-ELV-SM120-BLUE

Date and time:

10-Aug-18 2:51:03 PM

Additional Information:

LED: RGBW (6500K)

FIXTURE: FL25

FILM: 250269 (40°X10°)

COLOR-AMP: ON

STABILIZED: YES

COLOR (RGBW): BLUE

FWHM: 39.4°X10.7°

PERFORMED BY: ABDULLAH QURESHI

Color

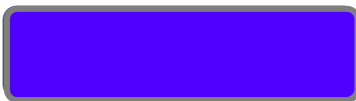

CIE 1931

x: 0.150

y: 0.029

Spectra

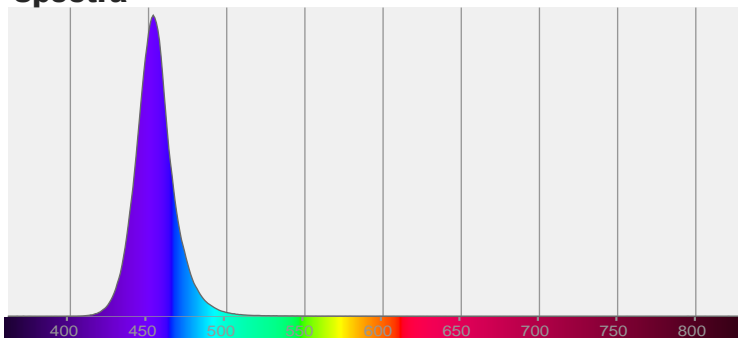

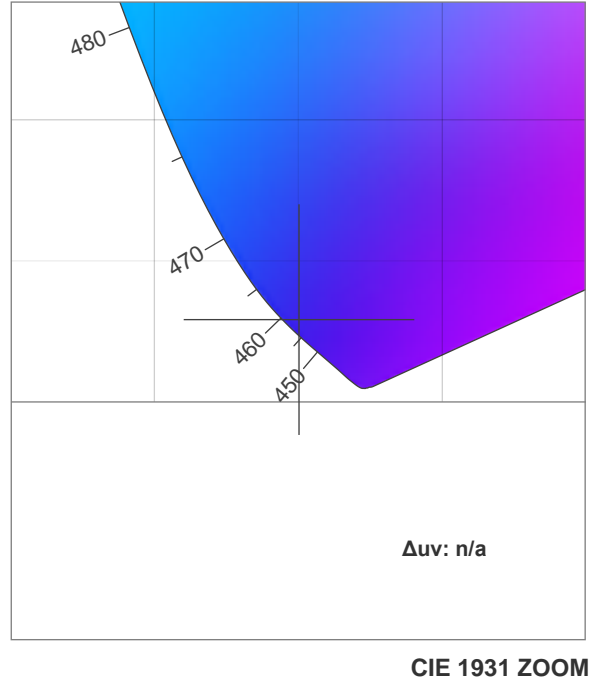
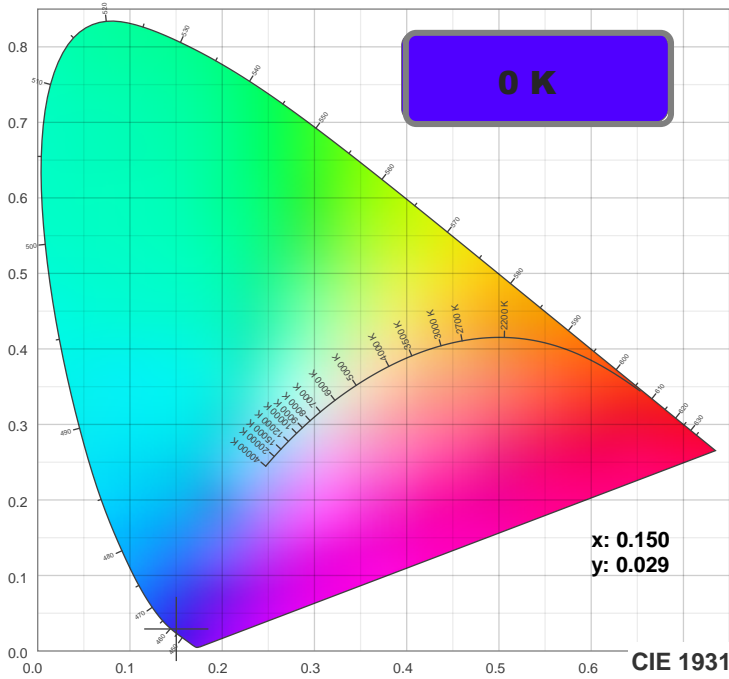

TM30: 0.0

CRI: 0.0 (R1-R8)

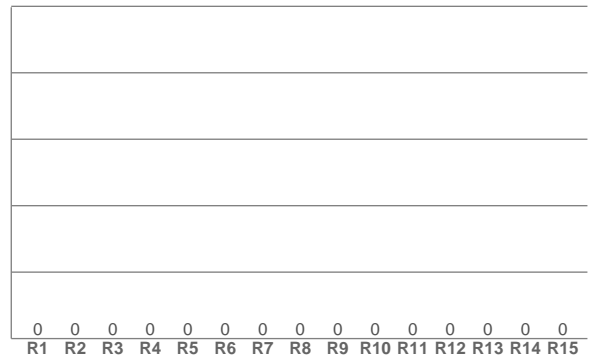
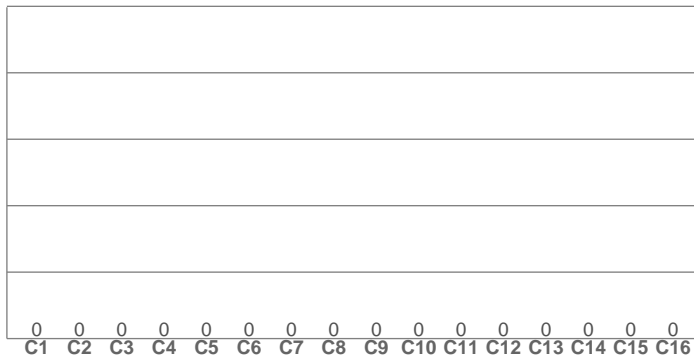

CRI R values, only R1-R8 are used to calculate final CRI value

R1	R2	R3	R4	R5	R6	R7	R8	R9	R10	R11	R12	R13	R14	R15
0.0	0.0	0.0	0.0	0.0	0.0	0.0	0.0	0.0	0.0	0.0	0.0	0.0	0.0	0.0

TM30 C values, 16 binned values out of total of 99 C values

C1	C2	C3	C4	C5	C6	C7	C8	C9	C10	C11	C12	C13	C14	C15	C16
0.0	0.0	0.0	0.0	0.0	0.0	0.0	0.0	0.0	0.0	0.0	0.0	0.0	0.0	0.0	0.0

CQS Q values

Q1	Q2	Q3	Q4	Q5	Q6	Q7	Q8	Q9	Q10	Q11	Q12	Q13	Q14	Q15
0.0	0.0	0.0	0.0	0.0	0.0	0.0	0.0	0.0	0.0	0.0	0.0	0.0	0.0	0.0

CQS: 0.0

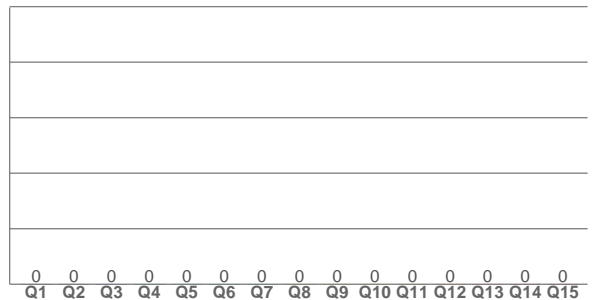

Color parameters

Color temperature	Color rendering index	Red component	Color fidelity	Color gamut	Color quality scale	Color coordinate cie 1931	Color coordinate cie 1931	Color coordinate	Color coordinate	Color deviation from black body
CCT	CRI	CRI R9	TM30 Rf	TM30 Rg	CQS	x	y	u	v	Δuv
0 K	0.0	0.0	0.0	0.0	0.0	0.150	0.029	0.197	0.057	n/a

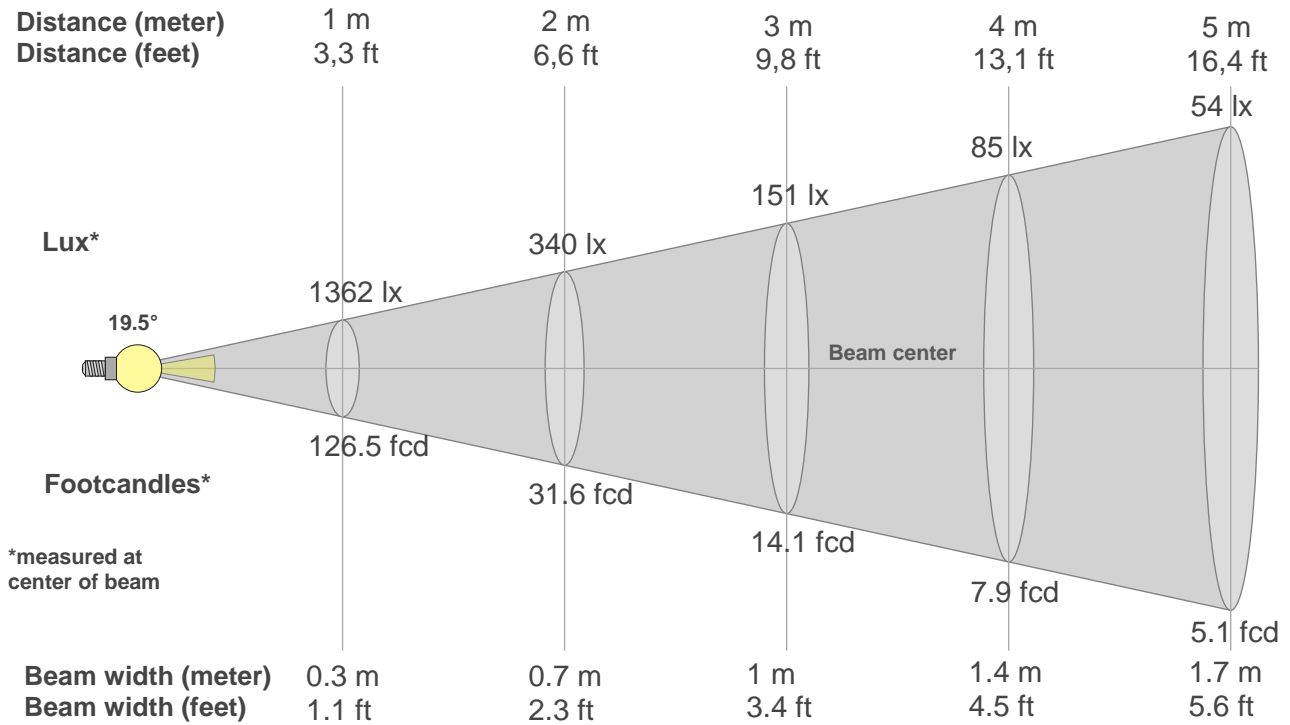

Beam intensities from 1-20m

1m	2m	3m	4m	5m	6m	7m	8m	9m	10m	11m	12m	13m	14m	15m	16m	17m	18m	19m	20m
3.3ft	6.6ft	9.8ft	13.1ft	16.4ft	19.7ft	23ft	26.2ft	29.5ft	32.8ft	36.1ft	39.4ft	42.7ft	45.9ft	49.2ft	52.5ft	55.8ft	59.1ft	62.3ft	65.6ft
1362lx	340lx	151lx	85lx	54lx	38lx	28lx	21lx	17lx	14lx	11lx	9lx	8lx	7lx	6lx	5lx	5lx	4lx	4lx	3lx
126.5fcd	31.6fcd	14.1fcd	7.9fcd	5.1fcd	3.5fcd	2.6fcd	2fcd	1.6fcd	1.3fcd	1fcd	0.9fcd	0.7fcd	0.6fcd	0.6fcd	0.5fcd	0.4fcd	0.4fcd	0.4fcd	0.3fcd

Intensities in 0° c-plane

0°	1°	2°	3°	4°	5°	6°	7°	8°	9°	10°	11°	12°	13°	14°	15°	16°	17°	18°	19°
1362	1346	1282	1131	977	792	608	470	342	251	192	142	122	102	93	84	77	71	64	58
100%	99%	94%	83%	72%	58%	45%	35%	25%	18%	14%	10%	9%	7%	7%	6%	6%	5%	5%	4%

Intensities in 90° c-plane

0°	1°	2°	3°	4°	5°	6°	7°	8°	9°	10°	11°	12°	13°	14°	15°	16°	17°	18°	19°
1362	1409	1407	1400	1393	1380	1367	1348	1327	1301	1269	1235	1188	1141	1085	1025	961	892	823	754
100%	103%	103%	103%	102%	101%	100%	99%	97%	96%	93%	91%	87%	84%	80%	75%	71%	66%	60%	55%

Intensities in 180° c-plane

0°	1°	2°	3°	4°	5°	6°	7°	8°	9°	10°	11°	12°	13°	14°	15°	16°	17°	18°	19°
1362	1346	1282	1131	977	792	608	470	342	251	192	142	122	102	93	84	77	71	64	58
100%	99%	94%	83%	72%	58%	45%	35%	25%	18%	14%	10%	9%	7%	7%	6%	6%	5%	5%	4%

Intensities in 270° c-plane

0°	1°	2°	3°	4°	5°	6°	7°	8°	9°	10°	11°	12°	13°	14°	15°	16°	17°	18°	19°
1362	1409	1407	1400	1393	1380	1367	1348	1327	1301	1269	1235	1188	1141	1085	1025	961	892	823	754
100%	103%	103%	103%	102%	101%	100%	99%	97%	96%	93%	91%	87%	84%	80%	75%	71%	66%	60%	55%

Beam angle 50%	Field angle 10%	Cutoff angle 2,5%	Intensity ratio in 120° cone	Intensity ratio in 90° cone
19.5°	35.4°	58.9°	91.1%	87.8%