

Light efficiency:

39 Lumen/Watt

Light quality:

CRI: 0.0

Color temperature:

0 K

Output: 1937 lm

Peak: 1171 cd

Power: 50.0 W

PF: 1.0



79.1°

Beam angle

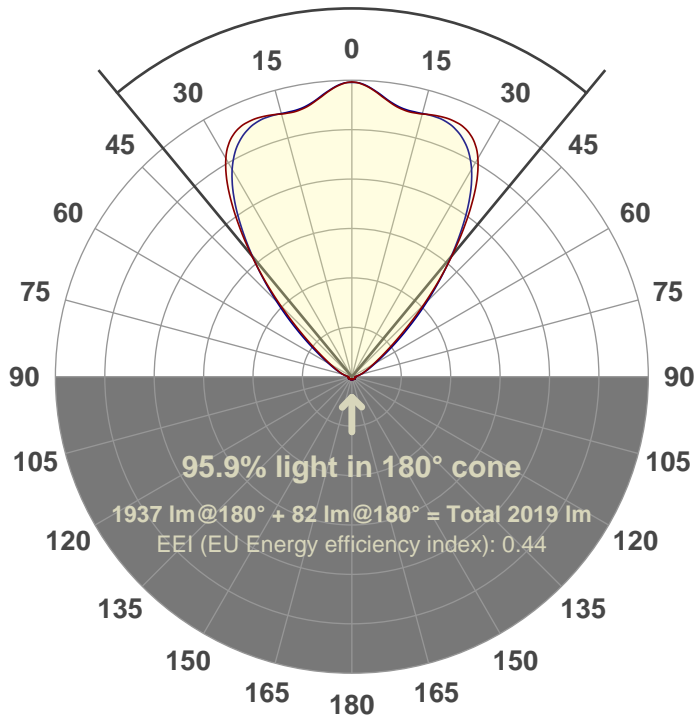

Color



CIE 1931
x: 0.156
y: 0.706

Product name:

FL50-CM-RGBW65K-IM-80-ELV-SM-GREEN

Date and time:

31-May-18 12:09:32 PM

Additional Information:

LED: RGBW

FIXTURE: FL50

FILM: 250259 (80°)

COLORAMP: ON

STABILIZED: YES

COLOR (RGBW): GREEN

PERFORMED BY: ABDULLAH QURESHI

Spectra

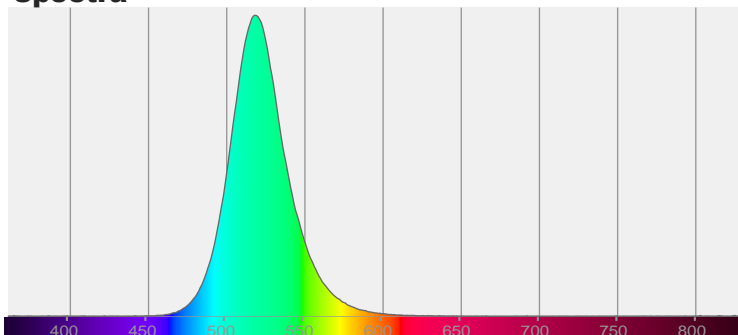

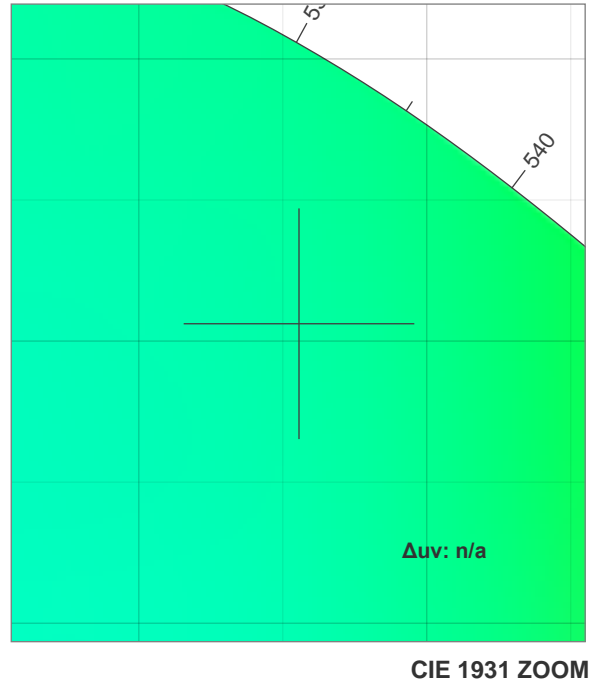
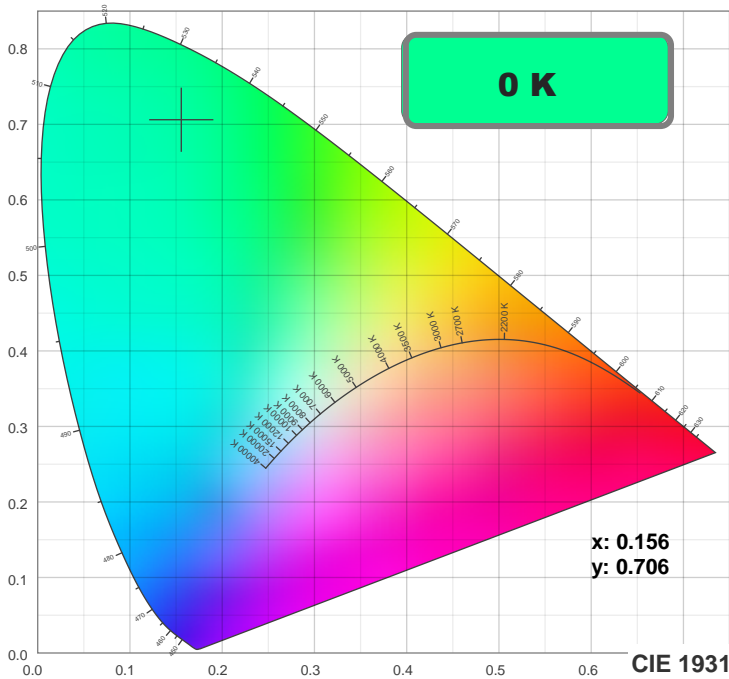

TM30: 0.0

CRI: 0.0 (R1-R8)

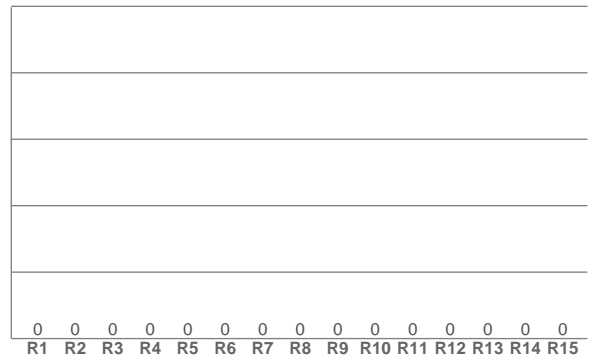
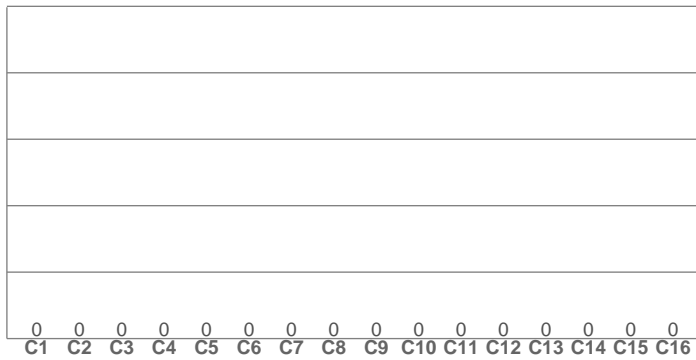

CRI R values, only R1-R8 are used to calculate final CRI value

R1	R2	R3	R4	R5	R6	R7	R8	R9	R10	R11	R12	R13	R14	R15
0.0	0.0	0.0	0.0	0.0	0.0	0.0	0.0	0.0	0.0	0.0	0.0	0.0	0.0	0.0

TM30 C values, 16 binned values out of total of 99 C values

C1	C2	C3	C4	C5	C6	C7	C8	C9	C10	C11	C12	C13	C14	C15	C16
0.0	0.0	0.0	0.0	0.0	0.0	0.0	0.0	0.0	0.0	0.0	0.0	0.0	0.0	0.0	0.0

CQS Q values

Q1	Q2	Q3	Q4	Q5	Q6	Q7	Q8	Q9	Q10	Q11	Q12	Q13	Q14	Q15
0.0	0.0	0.0	0.0	0.0	0.0	0.0	0.0	0.0	0.0	0.0	0.0	0.0	0.0	0.0

CQS: 0.0

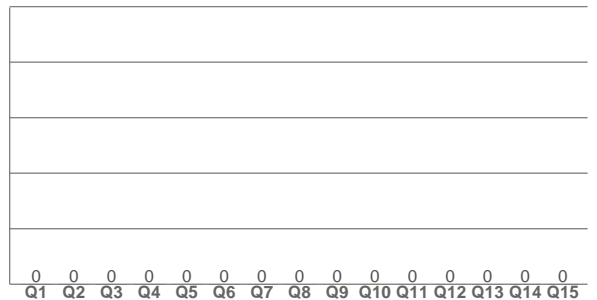

Color parameters

Color temperature	Color rendering index	Red component	Color fidelity	Color gamut	Color quality scale	Color coordinate cie 1931	Color coordinate cie 1931	Color coordinate	Color coordinate	Color deviation from black body
CCT	CRI	CRI R9	TM30 Rf	TM30 Rg	CQS	x	y	u	v	Δuv
0 K	0.0	0.0	0.0	0.0	0.0	0.156	0.706	0.056	0.380	n/a

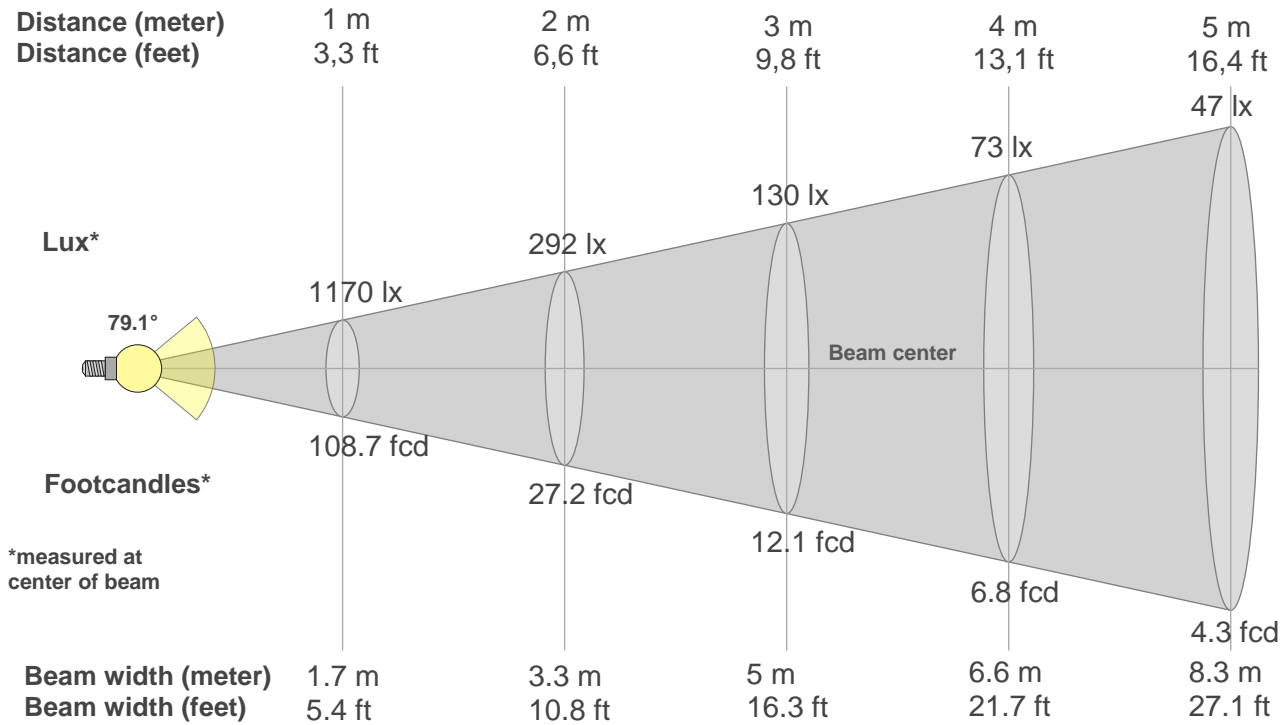

Beam intensities from 1-20m

1m	2m	3m	4m	5m	6m	7m	8m	9m	10m	11m	12m	13m	14m	15m	16m	17m	18m	19m	20m
3.3ft	6.6ft	9.8ft	13.1ft	16.4ft	19.7ft	23ft	26.2ft	29.5ft	32.8ft	36.1ft	39.4ft	42.7ft	45.9ft	49.2ft	52.5ft	55.8ft	59.1ft	62.3ft	65.6ft
1170lx	292lx	130lx	73lx	47lx	32lx	24lx	18lx	14lx	12lx	10lx	8lx	7lx	6lx	5lx	5lx	4lx	4lx	3lx	3lx
108.7fcd	27.2fcd	12.1fcd	6.8fcd	4.3fcd	3fcd	2.2fcd	1.7fcd	1.3fcd	1.1fcd	0.9fcd	0.8fcd	0.6fcd	0.6fcd	0.5fcd	0.4fcd	0.4fcd	0.3fcd	0.3fcd	0.3fcd

Intensities in 0° c-plane

0°	5°	10°	15°	20°	25°	30°	35°	40°	45°	50°	55°	60°	65°	70°	75°	80°	85°	90°	95°
1170	1134	1084	1081	1094	1081	1001	825	606	401	243	149	97	68	49	36	25	17	14	0
100%	97%	93%	92%	94%	92%	86%	71%	52%	34%	21%	13%	8%	6%	4%	3%	2%	1%	1%	0%

Intensities in 90° c-plane

0°	5°	10°	15°	20°	25°	30°	35°	40°	45°	50°	55°	60°	65°	70°	75°	80°	85°	90°	95°
1170	1136	1088	1082	1081	1043	951	793	602	422	272	168	108	74	52	37	25	17	14	0
100%	97%	93%	93%	92%	89%	81%	68%	51%	36%	23%	14%	9%	6%	4%	3%	2%	1%	1%	0%

Intensities in 180° c-plane

0°	5°	10°	15°	20°	25°	30°	35°	40°	45°	50°	55°	60°	65°	70°	75°	80°	85°	90°	95°
1170	1134	1084	1081	1094	1081	1001	825	606	401	243	149	97	68	49	36	25	17	14	0
100%	97%	93%	92%	94%	92%	86%	71%	52%	34%	21%	13%	8%	6%	4%	3%	2%	1%	1%	0%

Intensities in 270° c-plane

0°	5°	10°	15°	20°	25°	30°	35°	40°	45°	50°	55°	60°	65°	70°	75°	80°	85°	90°	95°
1170	1136	1088	1082	1081	1043	951	793	602	422	272	168	108	74	52	37	25	17	14	0
100%	97%	93%	93%	92%	89%	81%	68%	51%	36%	23%	14%	9%	6%	4%	3%	2%	1%	1%	0%

Beam angle 50%	Field angle 10%	Cutoff angle 2,5%	Intensity ratio in 120° cone	Intensity ratio in 90° cone
79.1°	115.8°	155.9°	89.6%	76.6%