

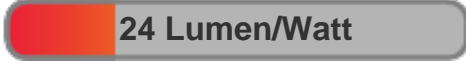

Light efficiency:



Light quality:



Color temperature:



Output: 439 lm
Peak: 5029 cd
Power: 18.3 W
48.2V @ 0.381A

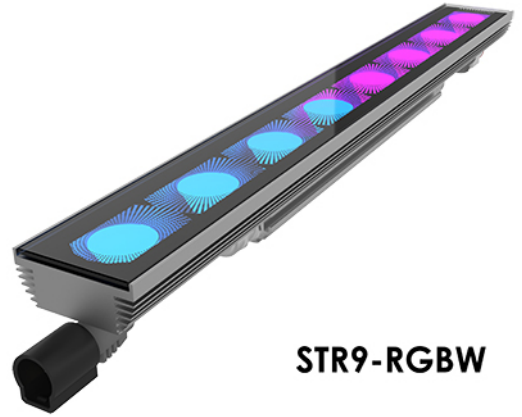

STR9-RGBW

Beam angle

13.1°

(6 PLANES)
12 C-Planes

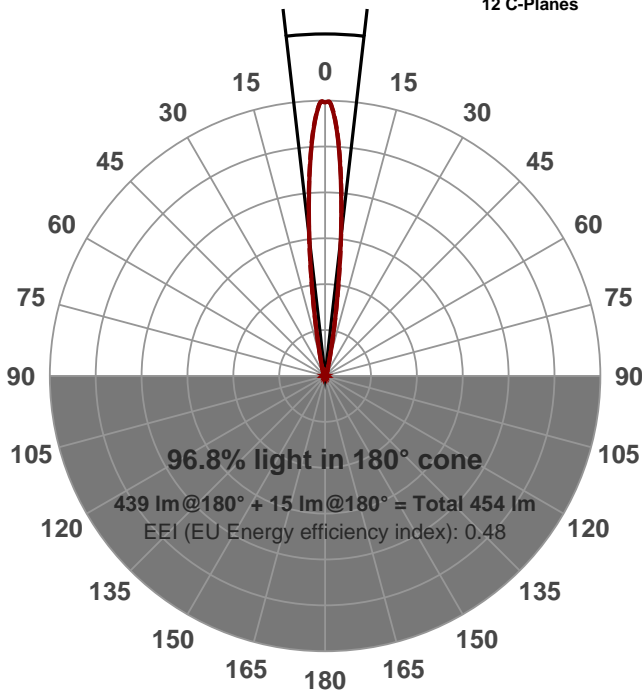

Product name:

STR9-300-CM-20W-RGBW-13-ELV-GREEN

Date and time:

2016-09-19 2:56:31 PM

Additional information:

FILM: 250201 BEAM MIXING

LED: RGBW (3000K)

FIXTURE: 1FT MODULE

NORMALIZED: YES

PERFORMED BY: NH

Color



CIE1931
x: 0.172
y: 0.700

Spectra

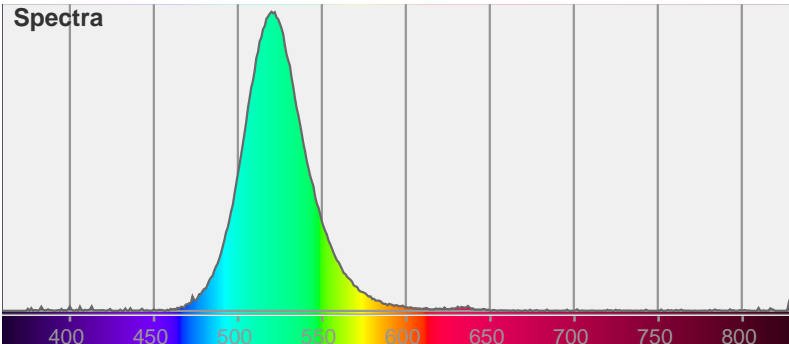

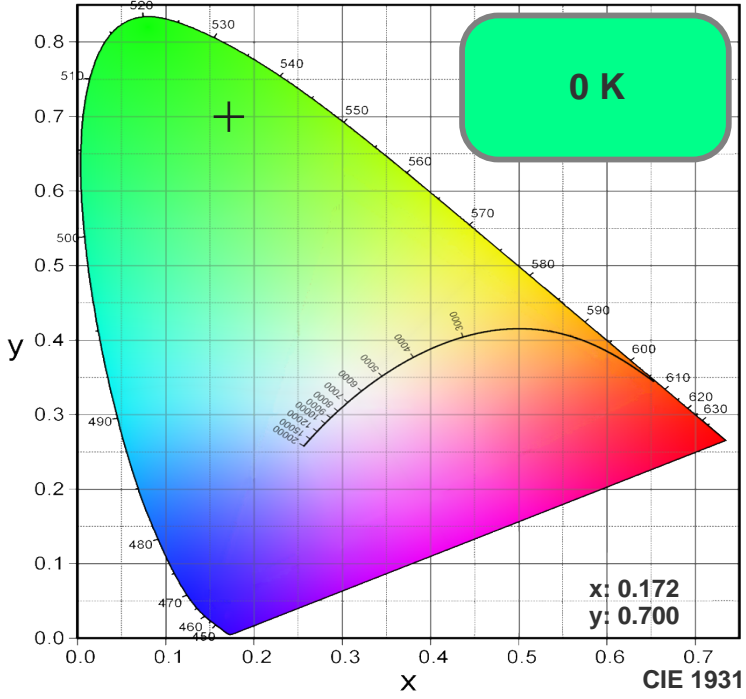

TM30: 0.0

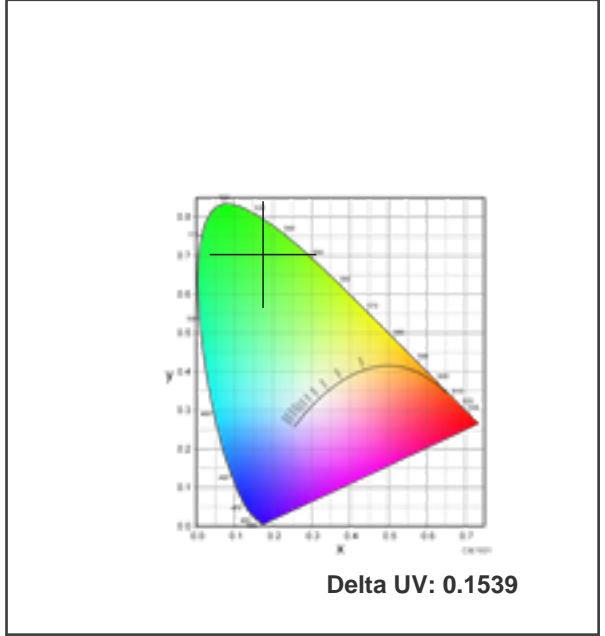

Delta UV: 0.1539

COLOR

CRI: 0.0 (R1-R8)

0	0	0	0	0	0	0	0	0	0	0	0	0	0	0	0
C1	C2	C3	C4	C5	C6	C7	C8	C9	C10	C11	C12	C13	C14	C15	C16

0	0	0	0	0	0	0	0	0	0	0	0	0	0	0	0
R1	R2	R3	R4	R5	R6	R7	R8	R9	R10	R11	R12	R13	R14	R15	R16

CRI R values, only R1-R8 are used to calculate final CRI value

R1	R2	R3	R4	R5	R6	R7	R8	R9	R10	R11	R12	R13	R14	R15
0.00	0.00	0.00	0.00	0.00	0.00	0.00	0.00	0.00	0.00	0.00	0.00	0.00	0.00	0.00

TM30 C values, 16 binned values out of total of 99 C values

C1	C2	C3	C4	C5	C6	C7	C8	C9	C10	C11	C12	C13	C14	C15	C16
0.00	0.00	0.00	0.00	0.00	0.00	0.00	0.00	0.00	0.00	0.00	0.00	0.00	0.00	0.00	0.00

CQS Q values

Q1	Q2	Q3	Q4	Q5	Q6	Q7	Q8	Q9	Q10	Q11	Q12	Q13	Q14	Q15
0.00	0.00	0.00	0.00	0.00	0.00	0.00	0.00	0.00	0.00	0.00	0.00	0.00	0.00	0.00

CQS: 0.0

0	0	0	0	0	0	0	0	0	0	0	0	0	0	0	0
Q1	Q2	Q3	Q4	Q5	Q6	Q7	Q8	Q9	Q10	Q11	Q12	Q13	Q14	Q15	Q16

Color parameters

CCT	CRI	CRI R9	TM30 Rf	TM30 Rg	CQS	x	y	u	v	Duv
0 K	0.0	0.0	0.0	0.0	0.0	0.2	0.7	0.1	0.4	0.0000

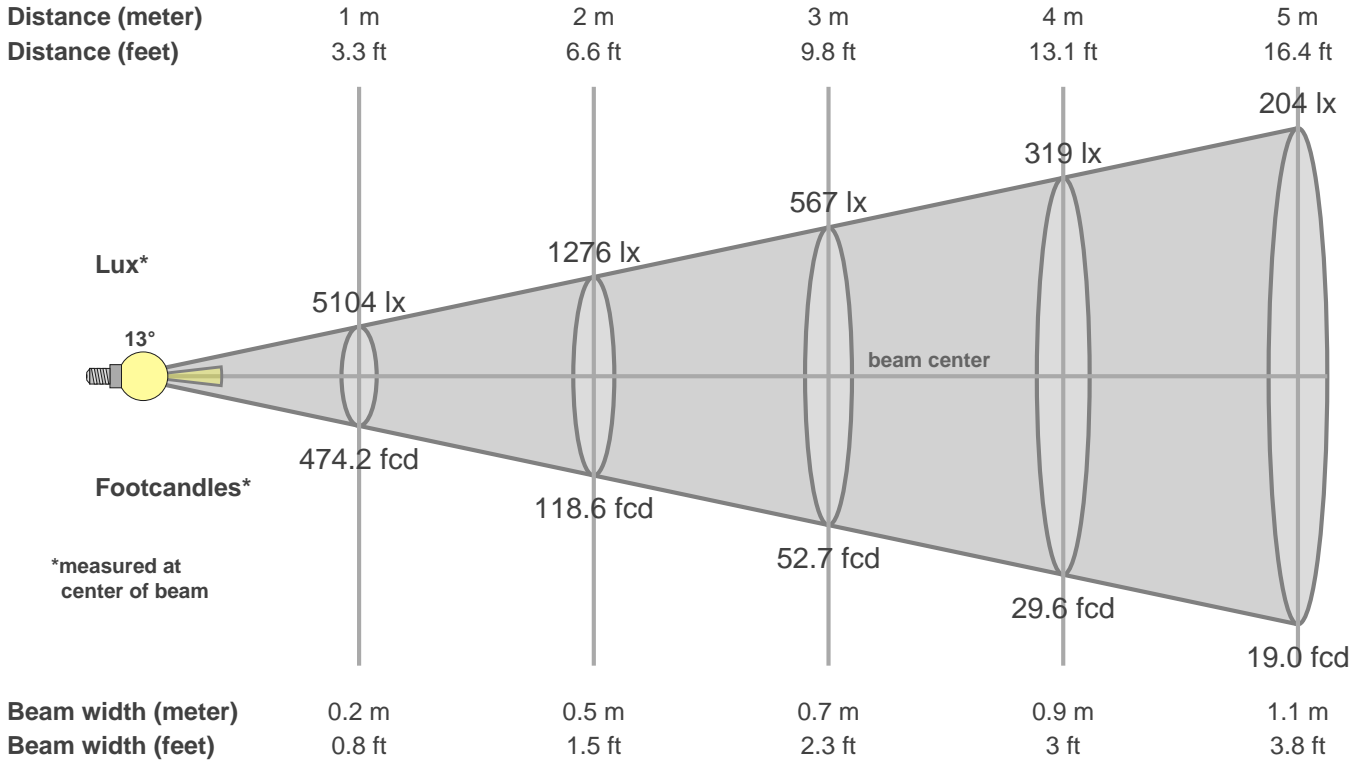

Intensities in 0° c-plane

0°	1°	2°	3°	4°	5°	6°	7°	8°	9°	10°	11°	12°	13°	14°	15°	16°	17°	18°	19°
5104	5026	4779	4406	3924	3385	2834	2304	1817	1402	1067	811	616	480	386	320	272	236	208	187
100%	98%	94%	86%	77%	66%	56%	45%	36%	27%	21%	16%	12%	9%	8%	6%	5%	5%	4%	4%

Intensities in 90° c-plane

0°	1°	2°	3°	4°	5°	6°	7°	8°	9°	10°	11°	12°	13°	14°	15°	16°	17°	18°	19°
5104	5029	4795	4430	3954	3424	2861	2327	1834	1414	1067	802	608	469	373	306	258	226	199	176
100%	99%	94%	87%	77%	67%	56%	46%	36%	28%	21%	16%	12%	9%	7%	6%	5%	4%	4%	3%

Intensities in 180° c-plane

0°	1°	2°	3°	4°	5°	6°	7°	8°	9°	10°	11°	12°	13°	14°	15°	16°	17°	18°	19°
5104	5026	4779	4406	3924	3385	2834	2304	1817	1402	1067	811	616	480	386	320	272	236	208	187
100%	98%	94%	86%	77%	66%	56%	45%	36%	27%	21%	16%	12%	9%	8%	6%	5%	5%	4%	4%

Intensities in 270° c-plane

0°	1°	2°	3°	4°	5°	6°	7°	8°	9°	10°	11°	12°	13°	14°	15°	16°	17°	18°	19°
5104	5029	4795	4430	3954	3424	2861	2327	1834	1414	1067	802	608	469	373	306	258	226	199	176
100%	99%	94%	87%	77%	67%	56%	46%	36%	28%	21%	16%	12%	9%	7%	6%	5%	4%	4%	3%

Beam angle 50%	Field angle 10%	Cutoff angle 2.5%	Intensity ratio in 120° cone	Intensity ratio in 90° cone
13.1°	25.4°	43.9°	94.0%	90.5%