

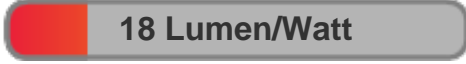

Light efficiency:



Light quality:



Color temperature:



Output: 256 lm  
Peak: 2944 cd  
Power: 14.3 W  
48.2V @ 0.297A

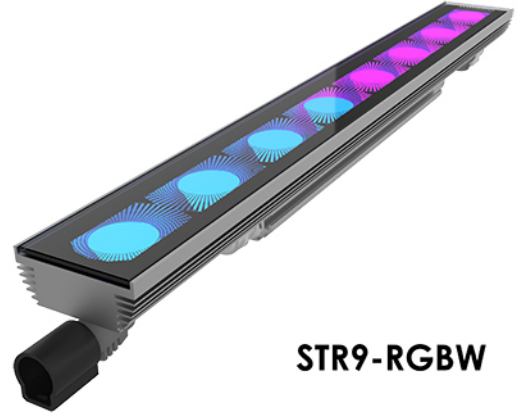

STR9-RGBW

Beam angle

13°

(6 PLANES)  
12 C-Planes

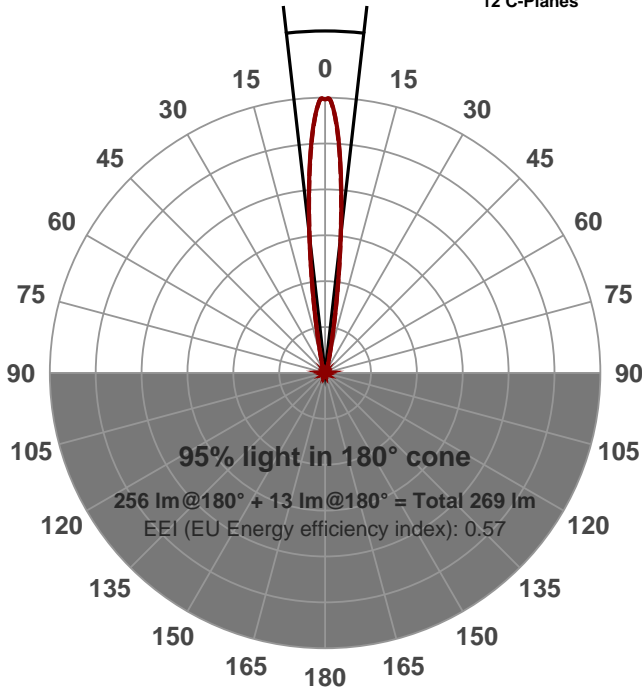

Product name:

STR9-300-CM-20W-RGBW-13-ELV-RED

Date and time:

2016-09-19 3:33:26 PM

Additional information:

FILM: 250201 BEAM MIXING

LED: RGBW (3000K)

FIXTURE: 1FT MODULE

NORMALIZED: YES

PERFORMED BY: NH

Color



CIE1931  
x: 0.699  
y: 0.297

Spectra

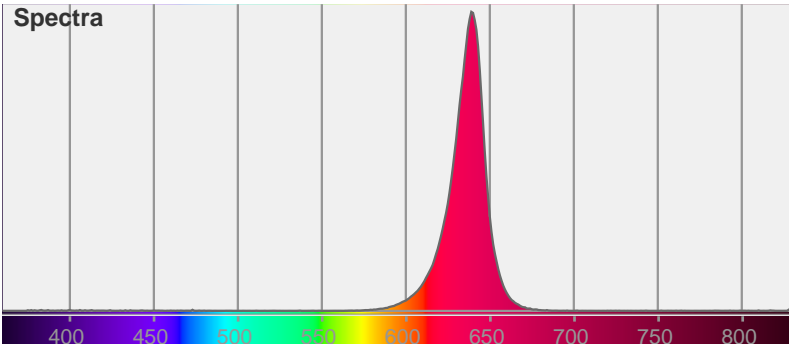

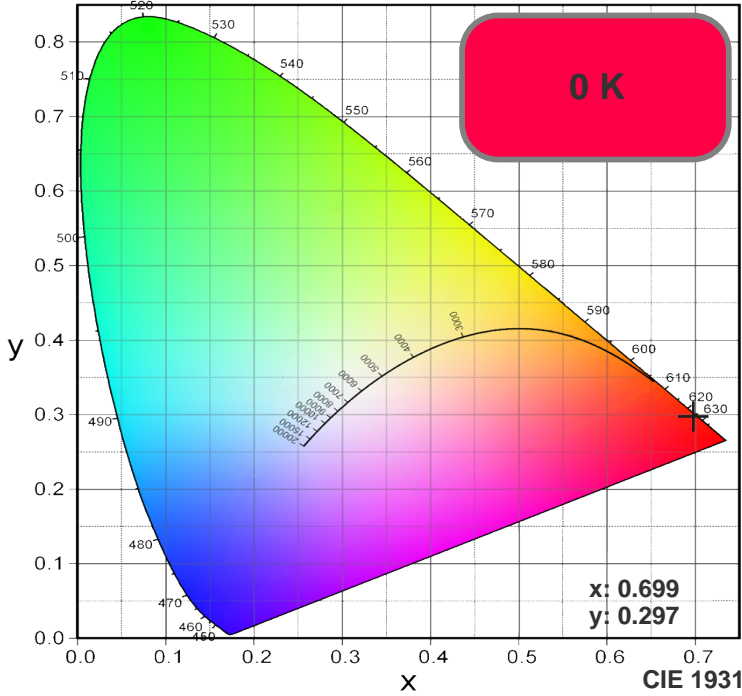

TM30: 0.0

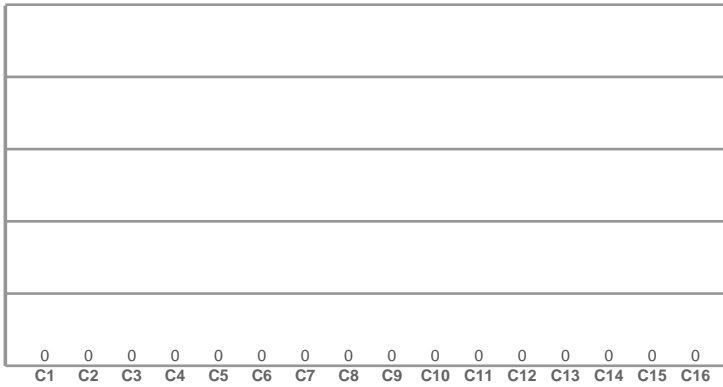

CRI R values, only R1-R8 are used to calculate final CRI value

R1	R2	R3	R4	R5	R6	R7	R8	R9	R10	R11	R12	R13	R14	R15
0.00	0.00	0.00	0.00	0.00	0.00	0.00	0.00	0.00	0.00	0.00	0.00	0.00	0.00	0.00

TM30 C values, 16 binned values out of total of 99 C values

C1	C2	C3	C4	C5	C6	C7	C8	C9	C10	C11	C12	C13	C14	C15	C16
0.00	0.00	0.00	0.00	0.00	0.00	0.00	0.00	0.00	0.00	0.00	0.00	0.00	0.00	0.00	0.00

CQS Q values

Q1	Q2	Q3	Q4	Q5	Q6	Q7	Q8	Q9	Q10	Q11	Q12	Q13	Q14	Q15
0.00	0.00	0.00	0.00	0.00	0.00	0.00	0.00	0.00	0.00	0.00	0.00	0.00	0.00	0.00

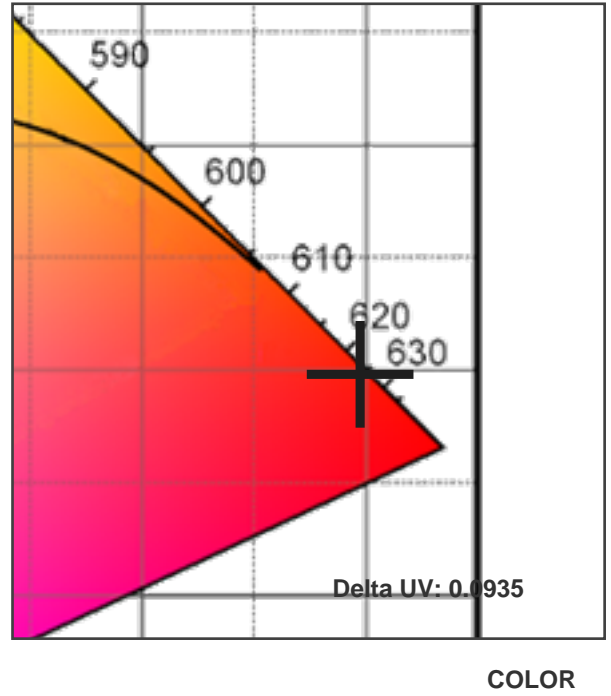

CRI: 0.0 (R1-R8)

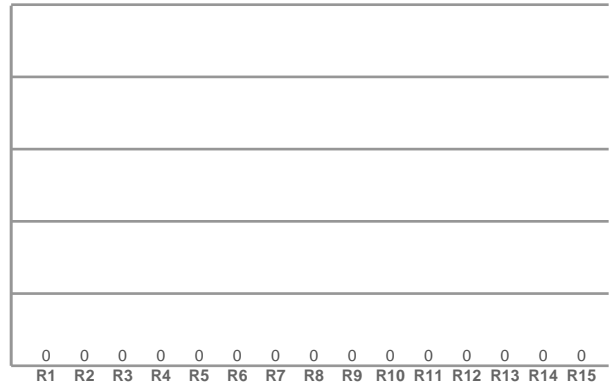

CQS: 0.0

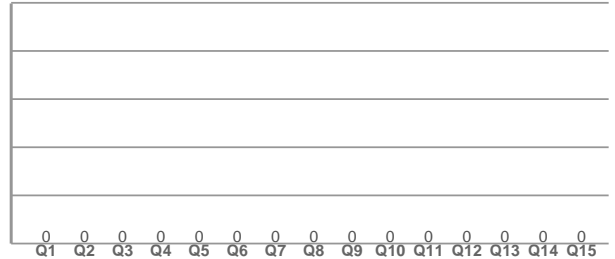

Color parameters

CCT	CRI	CRI R9	TM30 Rf	TM30 Rg	CQS	x	y	u	v	Duv
0 K	0.0	0.0	0.0	0.0	0.0	0.7	0.3	0.5	0.3	0.0000

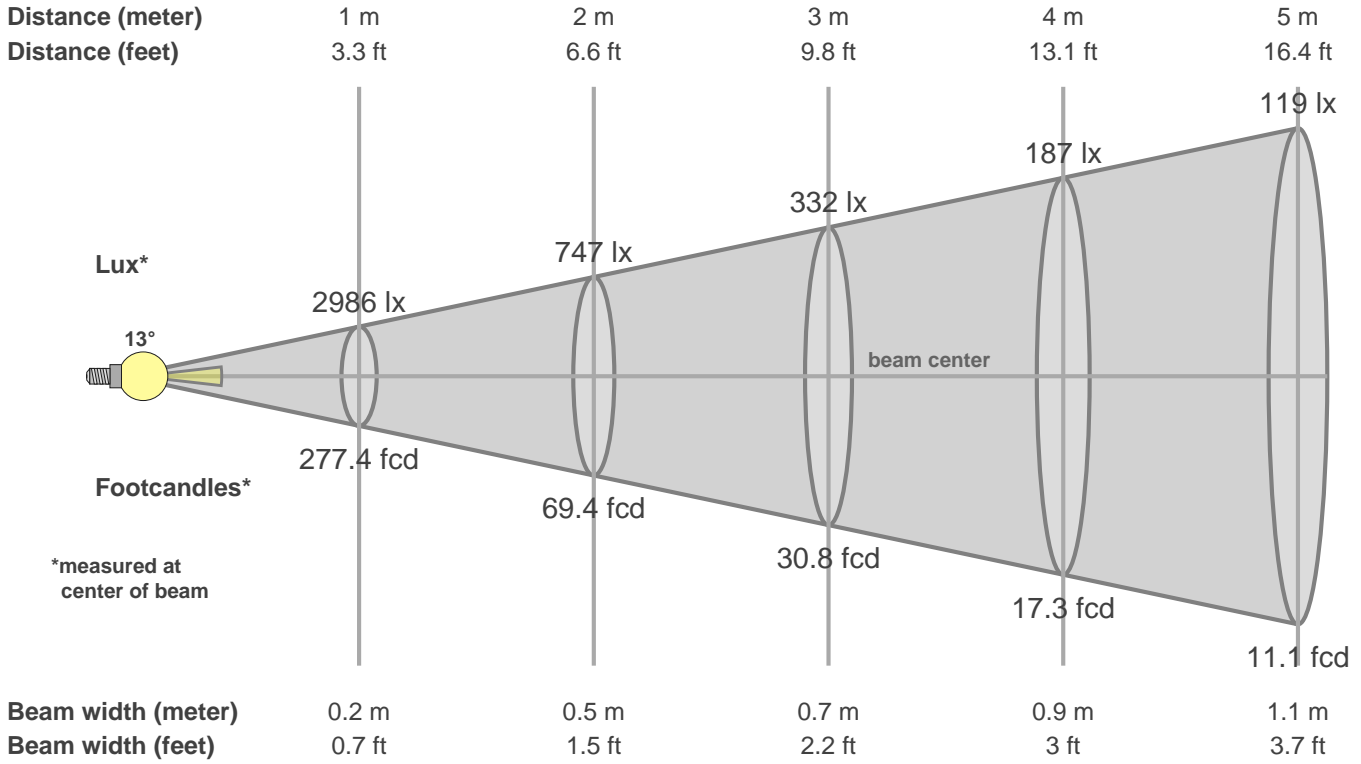

**Intensities in 0° c-plane**

0°	1°	2°	3°	4°	5°	6°	7°	8°	9°	10°	11°	12°	13°	14°	15°	16°	17°	18°	19°
2986	2942	2806	2592	2312	1989	1657	1335	1044	795	600	450	342	266	212	177	149	129	114	103
100%	99%	94%	87%	77%	67%	55%	45%	35%	27%	20%	15%	11%	9%	7%	6%	5%	4%	4%	3%

**Intensities in 90° c-plane**

0°	1°	2°	3°	4°	5°	6°	7°	8°	9°	10°	11°	12°	13°	14°	15°	16°	17°	18°	19°
2986	2941	2801	2576	2293	1970	1640	1321	1034	785	590	441	329	255	202	168	142	125	110	98
100%	99%	94%	86%	77%	66%	55%	44%	35%	26%	20%	15%	11%	9%	7%	6%	5%	4%	4%	3%

**Intensities in 180° c-plane**

0°	1°	2°	3°	4°	5°	6°	7°	8°	9°	10°	11°	12°	13°	14°	15°	16°	17°	18°	19°
2986	2942	2806	2592	2312	1989	1657	1335	1044	795	600	450	342	266	212	177	149	129	114	103
100%	99%	94%	87%	77%	67%	55%	45%	35%	27%	20%	15%	11%	9%	7%	6%	5%	4%	4%	3%

**Intensities in 270° c-plane**

0°	1°	2°	3°	4°	5°	6°	7°	8°	9°	10°	11°	12°	13°	14°	15°	16°	17°	18°	19°
2986	2941	2801	2576	2293	1970	1640	1321	1034	785	590	441	329	255	202	168	142	125	110	98
100%	99%	94%	86%	77%	66%	55%	44%	35%	26%	20%	15%	11%	9%	7%	6%	5%	4%	4%	3%

Beam angle 50%	Field angle 10%	Cutoff angle 2.5%	Intensity ratio in 120° cone	Intensity ratio in 90° cone
13.0°	24.9°	43.2°	91.3%	87.3%