

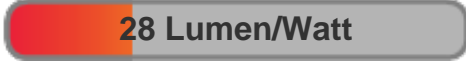

Light efficiency:



Light quality:



Color temperature:

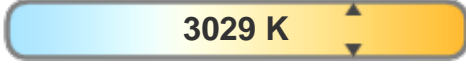

Output: 453 lm
Peak: 5623 cd
Power: 16.4 W
48.2V @ 0.342A

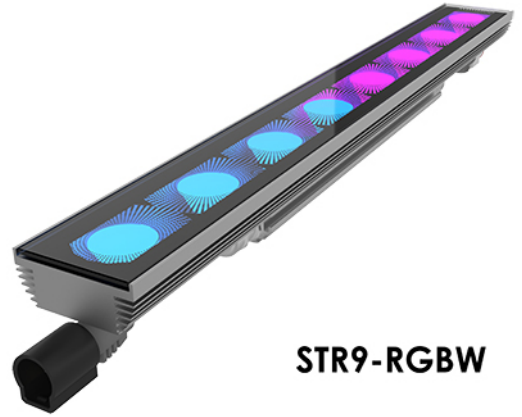

STR9-RGBW

Beam angle

12.5°

(6 PLANES)
12 C-Planes

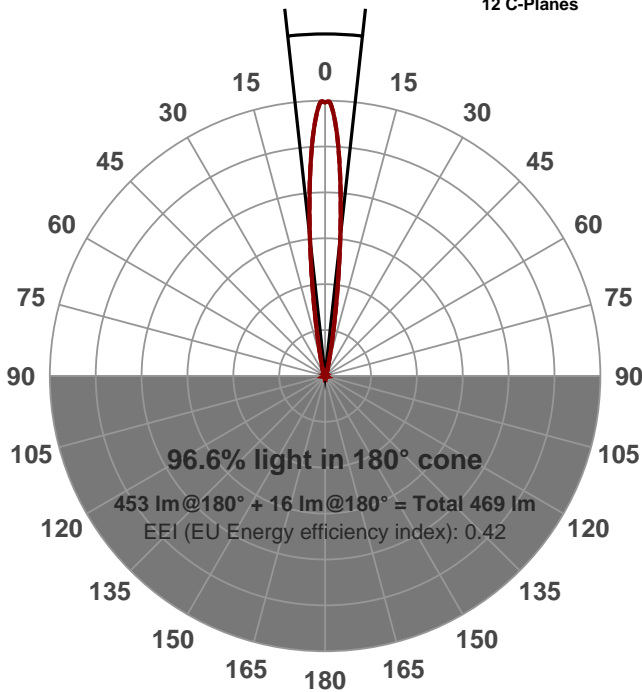

Product name:

STR9-300-CM-20W-RGBW-13-ELV-WHITE

Date and time:

2016-09-19 4:15:48 PM

Additional information:

FILM: 250201 BEAM MIXING

LED: RGBW (3000K)

FIXTURE: 1FT MODULE

NORMALIZED: YES

PERFORMED BY: NH

Color



CIE1931
x: 0.437
y: 0.408

Spectra

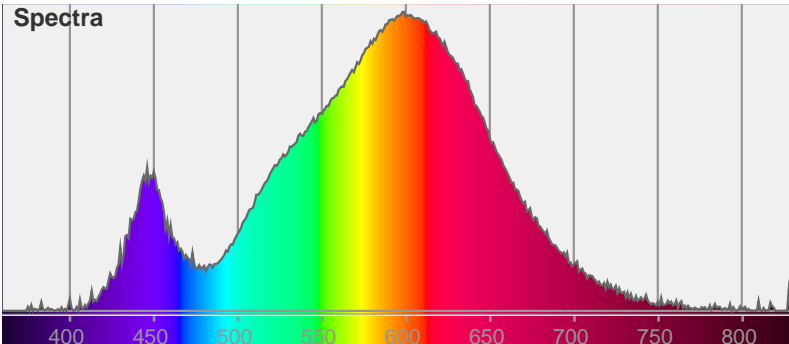

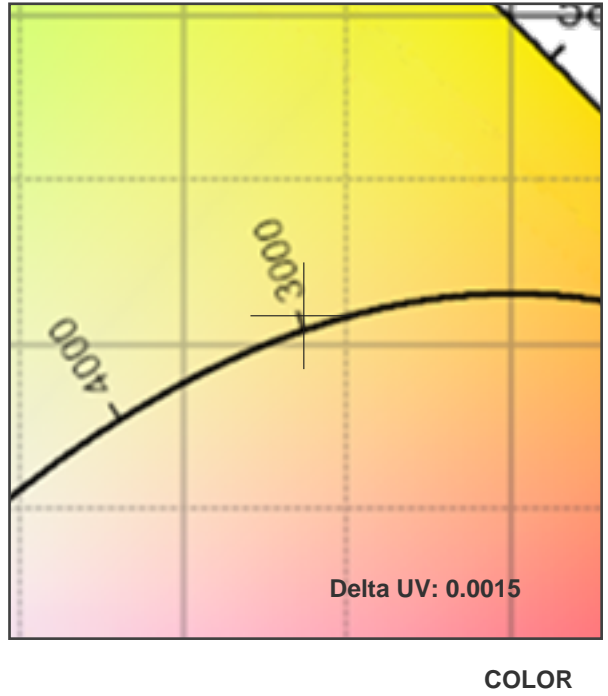
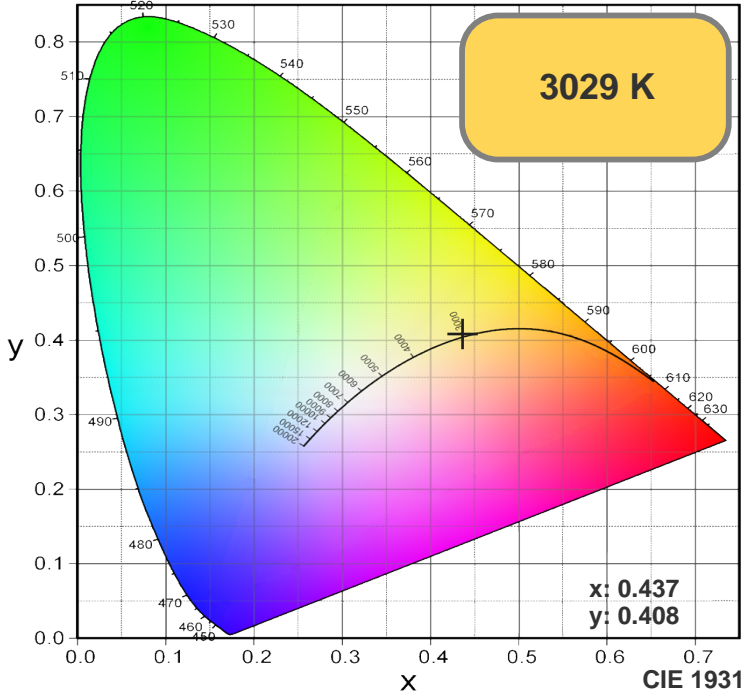

TM30: 79.0

CRI: 78.9 (R1-R8)

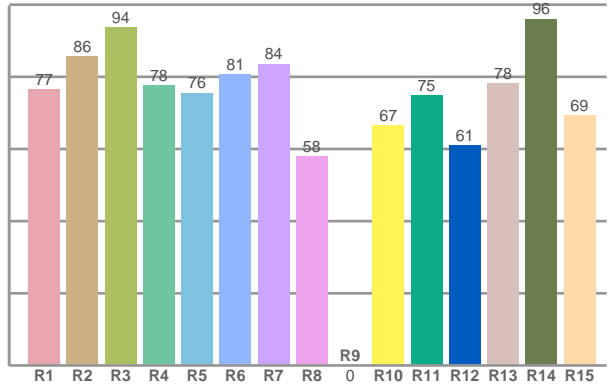
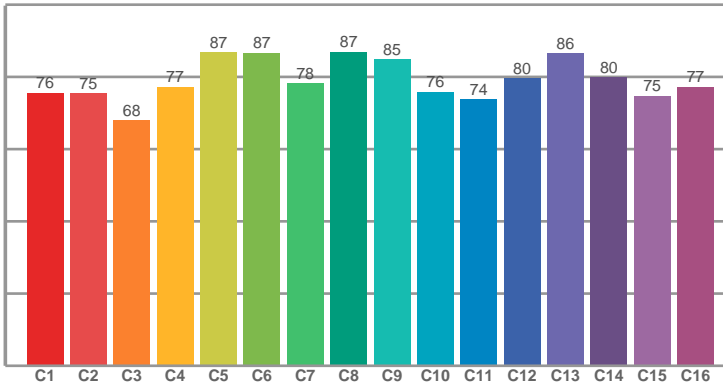

CRI R values, only R1-R8 are used to calculate final CRI value

R1	R2	R3	R4	R5	R6	R7	R8	R9	R10	R11	R12	R13	R14	R15
76.57	85.70	93.67	77.72	75.62	80.74	83.63	57.93	-0.09	66.52	74.84	61.06	78.17	96.05	69.29

TM30 C values, 16 binned values out of total of 99 C values

C1	C2	C3	C4	C5	C6	C7	C8	C9	C10	C11	C12	C13	C14	C15	C16
75.55	75.38	67.94	77.24	86.80	86.61	78.22	86.92	84.90	75.80	73.72	79.56	86.41	79.81	74.76	77.23

CQS Q values

Q1	Q2	Q3	Q4	Q5	Q6	Q7	Q8	Q9	Q10	Q11	Q12	Q13	Q14	Q15
71.30	96.09	76.62	72.05	77.02	78.78	80.58	85.54	95.63	88.00	85.12	83.66	82.53	68.23	69.02

CQS: 78.8

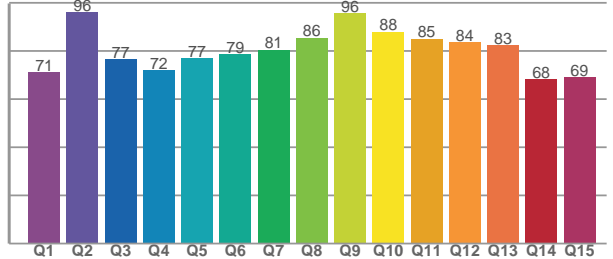

Color parameters

CCT	CRI	CRI R9	TM30 Rf	TM30 Rg	CQS	x	y	u	v	Duv
3029 K	78.9	-0.1	79.0	96.9	78.8	0.4	0.4	0.2	0.3	0.0015

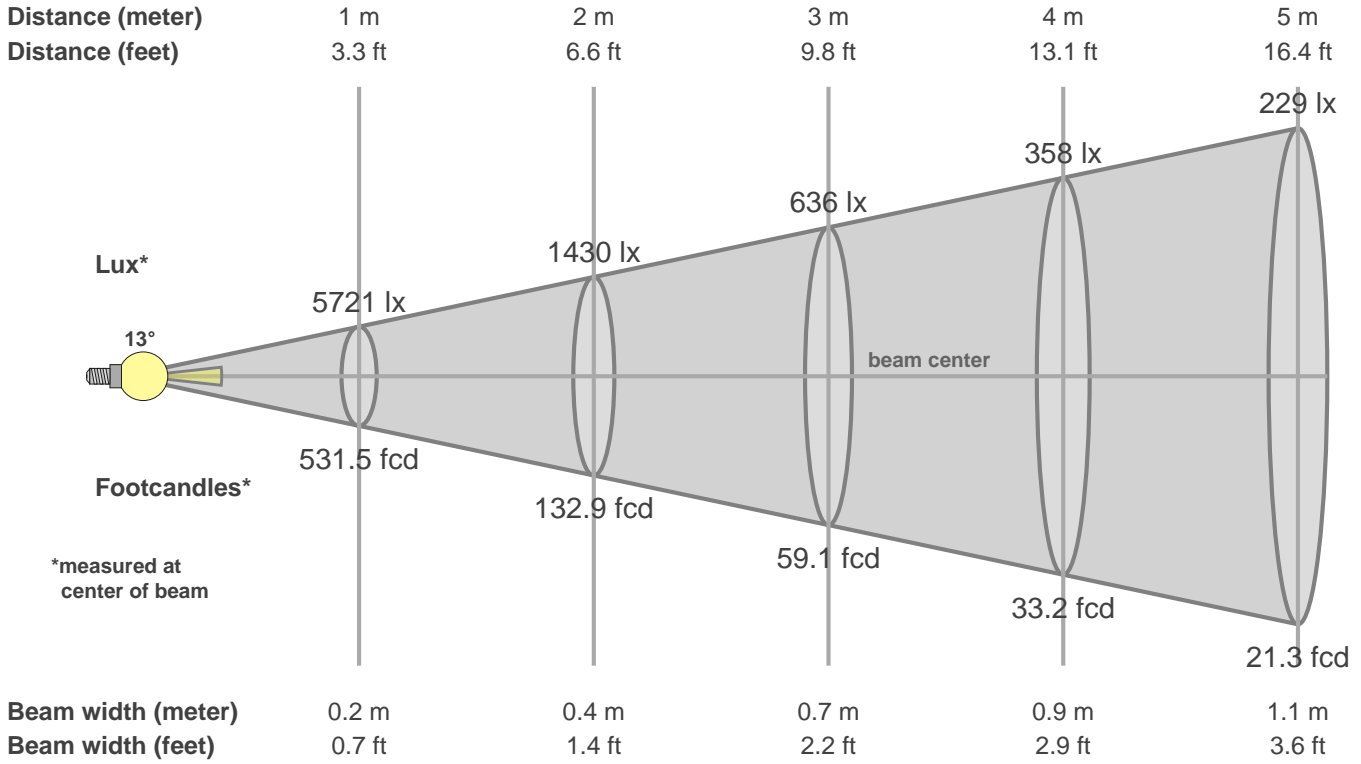

Intensities in 0° c-plane

0°	1°	2°	3°	4°	5°	6°	7°	8°	9°	10°	11°	12°	13°	14°	15°	16°	17°	18°	19°
5721	5622	5331	4880	4303	3664	3013	2402	1860	1412	1063	798	608	474	380	314	268	230	204	183
100%	98%	93%	85%	75%	64%	53%	42%	33%	25%	19%	14%	11%	8%	7%	5%	5%	4%	4%	3%

Intensities in 90° c-plane

0°	1°	2°	3°	4°	5°	6°	7°	8°	9°	10°	11°	12°	13°	14°	15°	16°	17°	18°	19°
5721	5618	5328	4877	4312	3681	3034	2425	1882	1425	1065	793	597	462	369	307	263	229	204	181
100%	98%	93%	85%	75%	64%	53%	42%	33%	25%	19%	14%	10%	8%	6%	5%	5%	4%	4%	3%

Intensities in 180° c-plane

0°	1°	2°	3°	4°	5°	6°	7°	8°	9°	10°	11°	12°	13°	14°	15°	16°	17°	18°	19°
5721	5622	5331	4880	4303	3664	3013	2402	1860	1412	1063	798	608	474	380	314	268	230	204	183
100%	98%	93%	85%	75%	64%	53%	42%	33%	25%	19%	14%	11%	8%	7%	5%	5%	4%	4%	3%

Intensities in 270° c-plane

0°	1°	2°	3°	4°	5°	6°	7°	8°	9°	10°	11°	12°	13°	14°	15°	16°	17°	18°	19°
5721	5618	5328	4877	4312	3681	3034	2425	1882	1425	1065	793	597	462	369	307	263	229	204	181
100%	98%	93%	85%	75%	64%	53%	42%	33%	25%	19%	14%	10%	8%	6%	5%	5%	4%	4%	3%

Beam angle 50%	Field angle 10%	Cutoff angle 2.5%	Intensity ratio in 120° cone	Intensity ratio in 90° cone
12.5°	24.4°	42.3°	94.0%	90.7%