

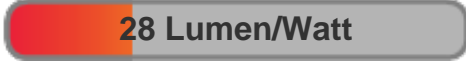

Light efficiency:



Light quality:



Color temperature:

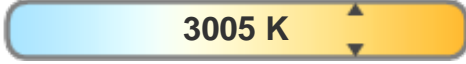

Output: 454 lm
Peak: 1351 cd
Power: 16.5 W
48.2V @ 0.342A



STR9-RGBW

Beam angle

26.2°

(6 PLANES)
12 C-Planes

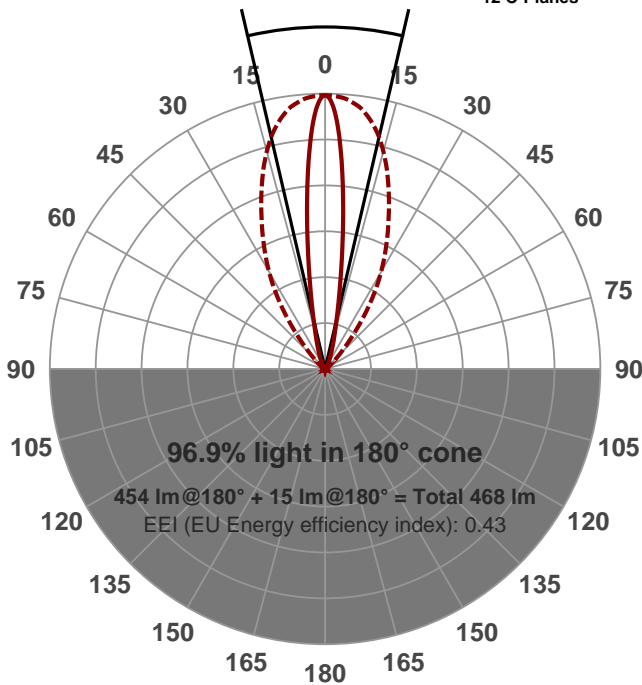

Product name:

STR9-300-CM-20W-RGBW-15X50-ELV

Date and time:

2016-09-21 1:25:51 PM

Additional information:

FILM: 250169

LED: RGBW (3000K)

FIXTURE: 1FT MODULE

NORMALIZED: YES

PERFORMED BY: NH

Color



CIE1931
x: 0.441
y: 0.412

Spectra

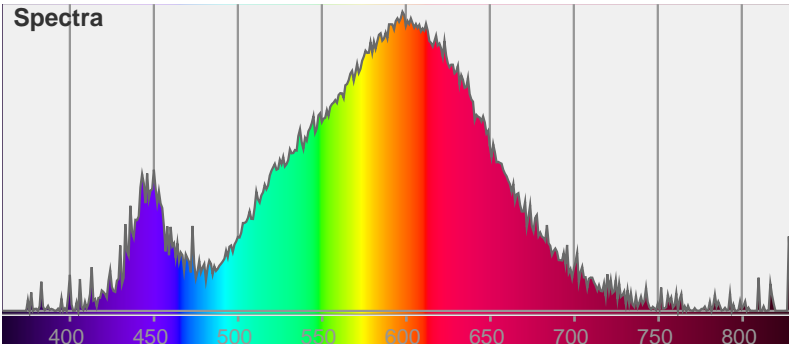

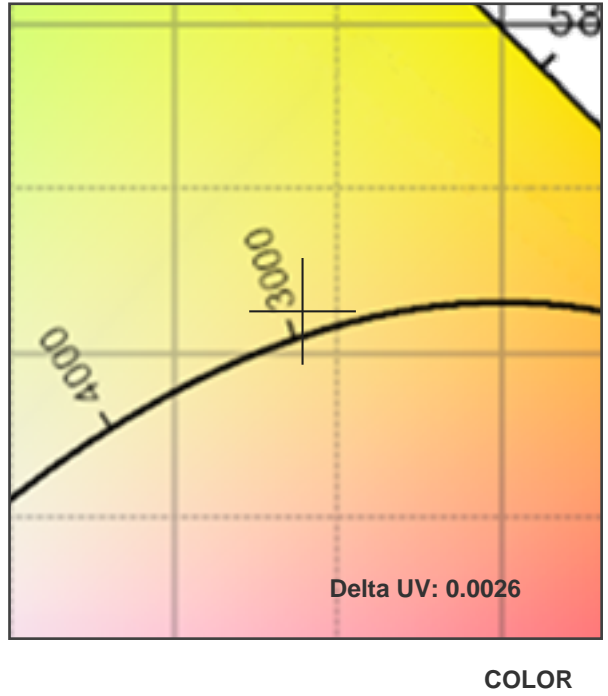
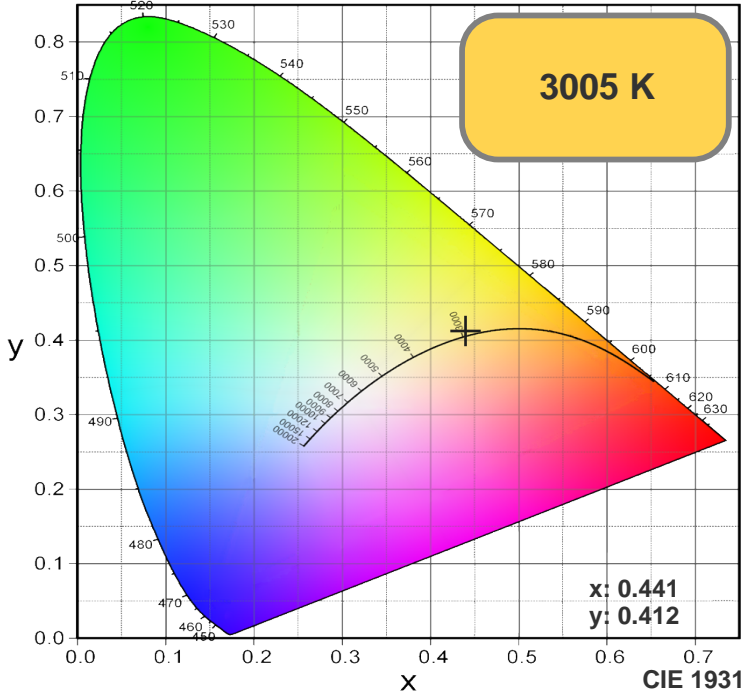

TM30: 79.0

CRI: 78.3 (R1-R8)

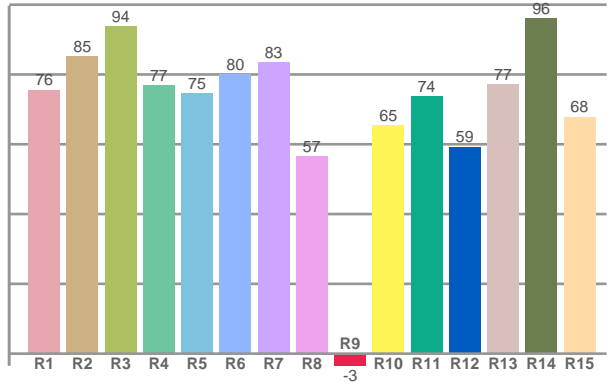
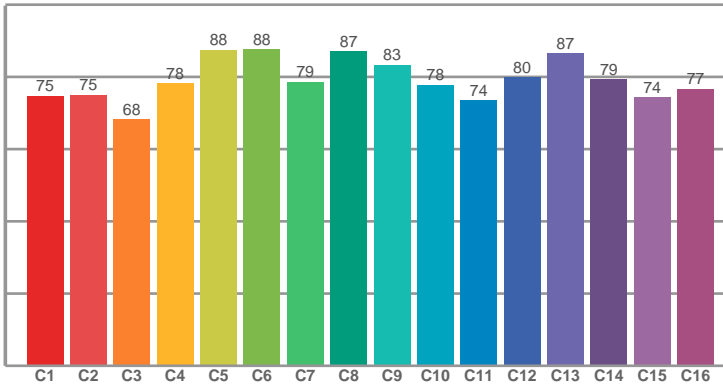

CRI R values, only R1-R8 are used to calculate final CRI value

R1	R2	R3	R4	R5	R6	R7	R8	R9	R10	R11	R12	R13	R14	R15
75.59	85.13	93.81	76.94	74.57	80.02	83.48	56.58	-3.48	65.37	73.81	59.22	77.24	96.13	67.90

TM30 C values, 16 binned values out of total of 99 C values

C1	C2	C3	C4	C5	C6	C7	C8	C9	C10	C11	C12	C13	C14	C15	C16
74.76	74.98	68.23	78.10	87.50	87.53	78.59	87.00	83.33	77.80	73.55	79.83	86.52	79.38	74.29	76.65

CQS Q values

Q1	Q2	Q3	Q4	Q5	Q6	Q7	Q8	Q9	Q10	Q11	Q12	Q13	Q14	Q15
67.70	95.43	75.46	68.03	73.31	76.90	79.92	86.84	95.19	90.64	85.53	83.86	82.13	66.08	66.17

CQS: 77.2

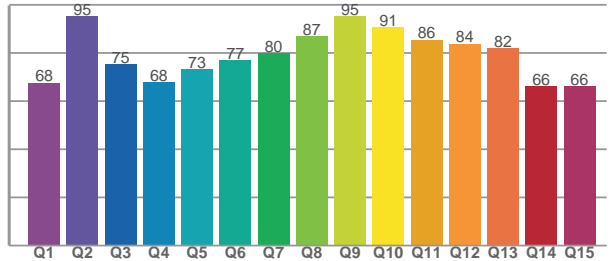

Color parameters

CCT	CRI	CRI R9	TM30 Rf	TM30 Rg	CQS	x	y	u	v	Duv
3005 K	78.3	-3.5	79.0	96.1	77.2	0.4	0.4	0.2	0.3	0.0026

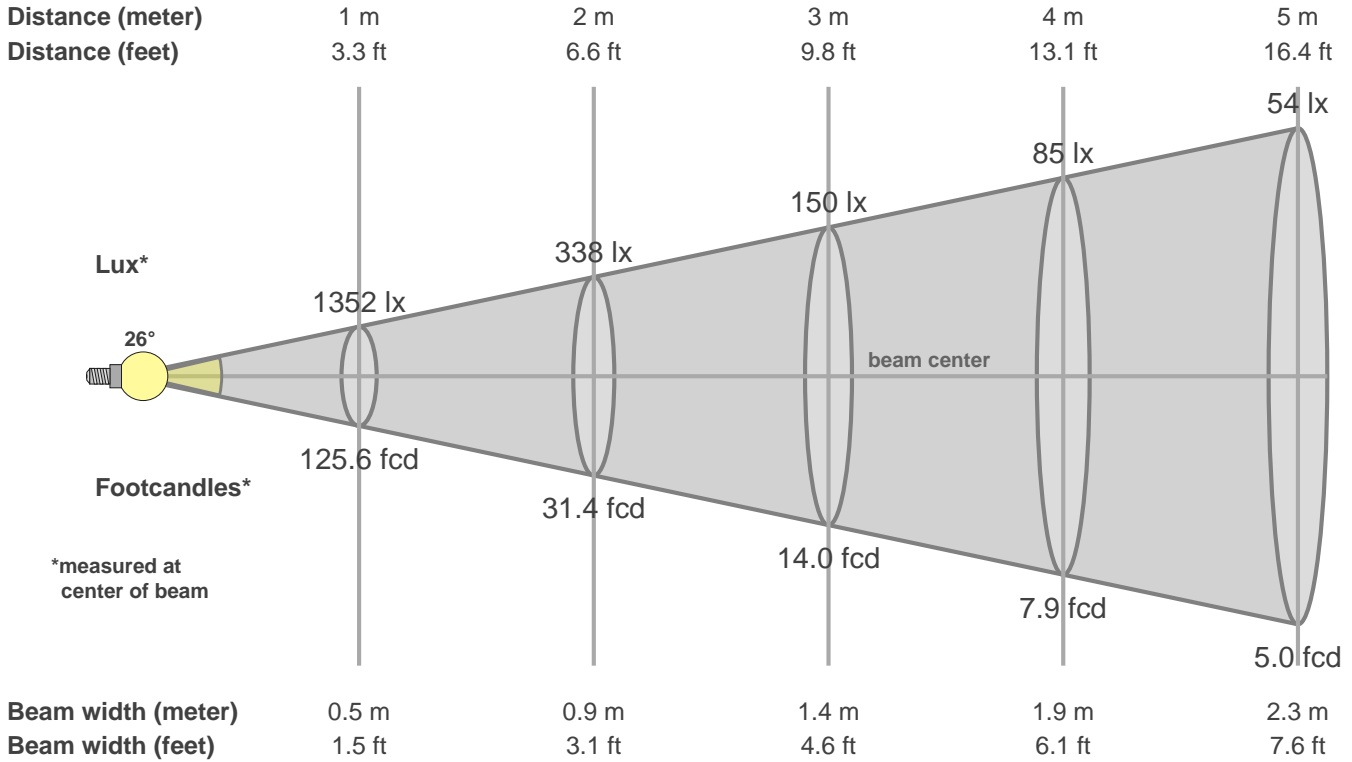

Intensities in 0° c-plane

0°	2°	4°	6°	8°	10°	12°	14°	16°	18°	20°	22°	24°	26°	28°	30°	32°	34°	36°	38°
1352	1282	1092	849	615	430	302	217	162	124	94	74	56	45	36	29	26	21	19	17
100%	95%	81%	63%	45%	32%	22%	16%	12%	9%	7%	5%	4%	3%	3%	2%	2%	2%	1%	1%

Intensities in 90° c-plane

0°	2°	4°	6°	8°	10°	12°	14°	16°	18°	20°	22°	24°	26°	28°	30°	32°	34°	36°	38°
1352	1349	1340	1322	1297	1257	1207	1146	1076	999	920	841	766	693	623	552	483	408	335	265
100%	100%	99%	98%	96%	93%	89%	85%	80%	74%	68%	62%	57%	51%	46%	41%	36%	30%	25%	20%

Intensities in 180° c-plane

0°	2°	4°	6°	8°	10°	12°	14°	16°	18°	20°	22°	24°	26°	28°	30°	32°	34°	36°	38°
1352	1282	1092	849	615	430	302	217	162	124	94	74	56	45	36	29	26	21	19	17
100%	95%	81%	63%	45%	32%	22%	16%	12%	9%	7%	5%	4%	3%	3%	2%	2%	2%	1%	1%

Intensities in 270° c-plane

0°	2°	4°	6°	8°	10°	12°	14°	16°	18°	20°	22°	24°	26°	28°	30°	32°	34°	36°	38°
1352	1349	1340	1322	1297	1257	1207	1146	1076	999	920	841	766	693	623	552	483	408	335	265
100%	100%	99%	98%	96%	93%	89%	85%	80%	74%	68%	62%	57%	51%	46%	41%	36%	30%	25%	20%

Beam angle 50%	Field angle 10%	Cutoff angle 2.5%	Intensity ratio in 120° cone	Intensity ratio in 90° cone
26.2°	51.9°	77.7°	93.5%	88.6%