

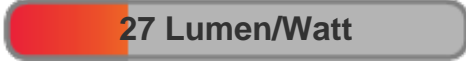

Light efficiency:



Light quality:



Color temperature:

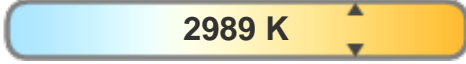

Output: 440 lm

Peak: 798 cd

Power: 16.5 W

48.2V @ 0.342A

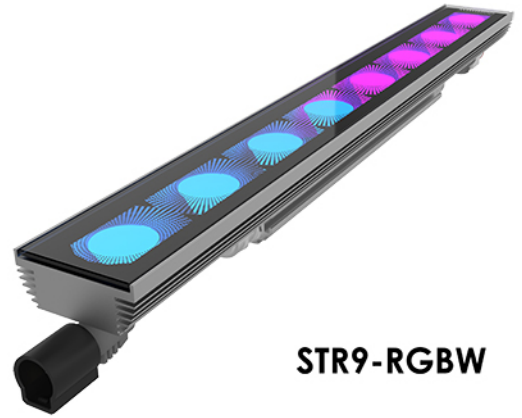

STR9-RGBW

Beam angle

37.5°

(6 PLANES)
12 C-Planes

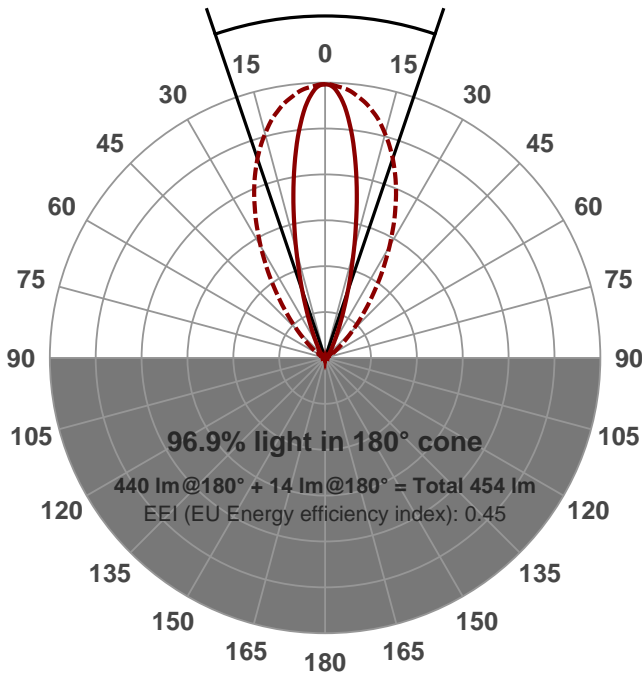

Product name:

STR9-300-CM-20W-RGBW-25X60-ELV

Date and time:

2016-09-21 1:07:02 PM

Additional information:

FILM: 250170

LED: RGBW (3000K)

FIXTURE: 1FT MODULE

NORMALIZED: YES

PERFORMED BY: NH

Color



CIE1931
x: 0.443
y: 0.414

Spectra

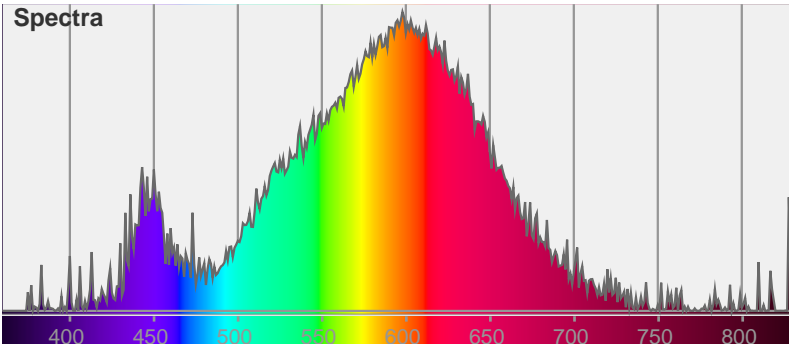

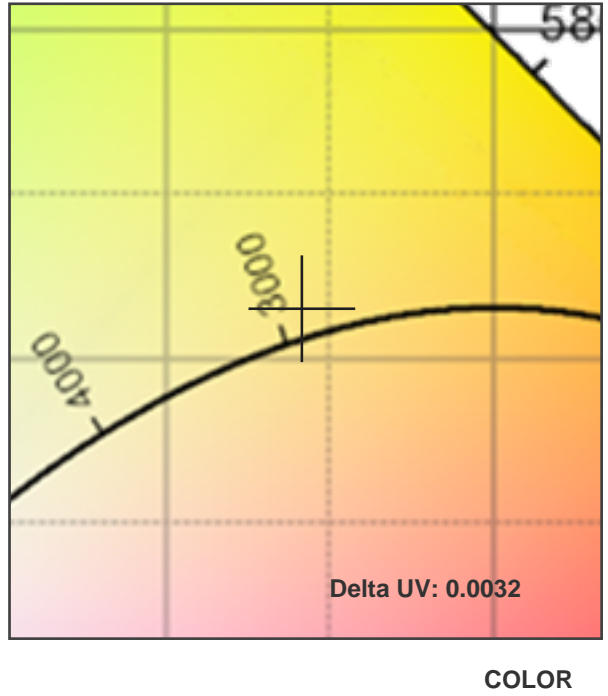
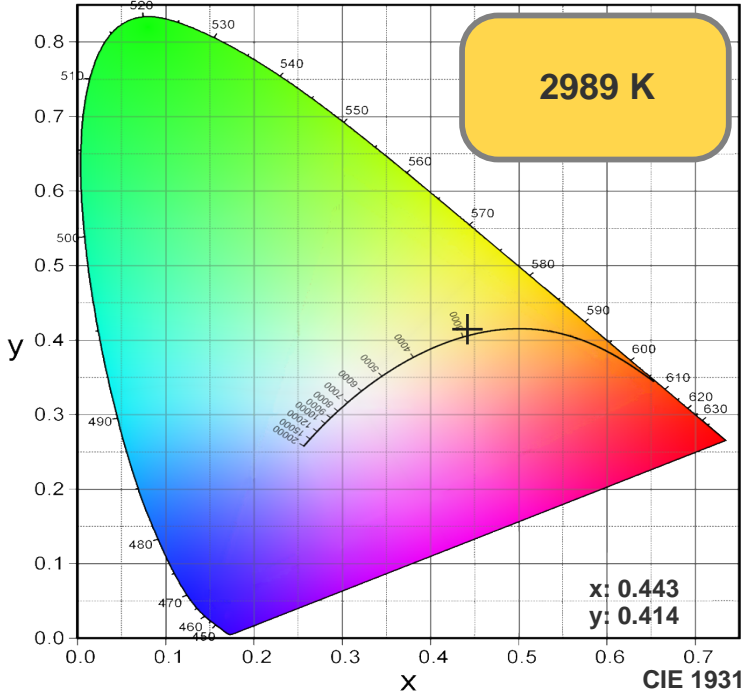

TM30: 78.8

CRI: 77.8 (R1-R8)

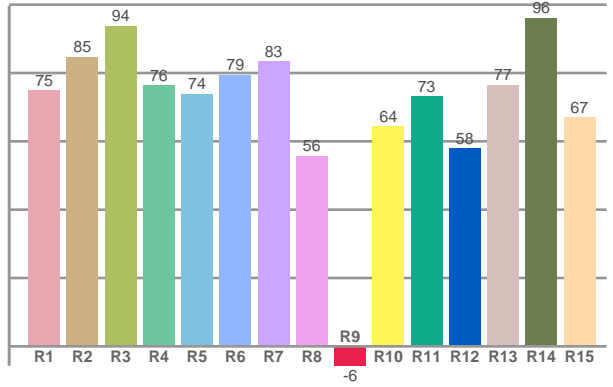
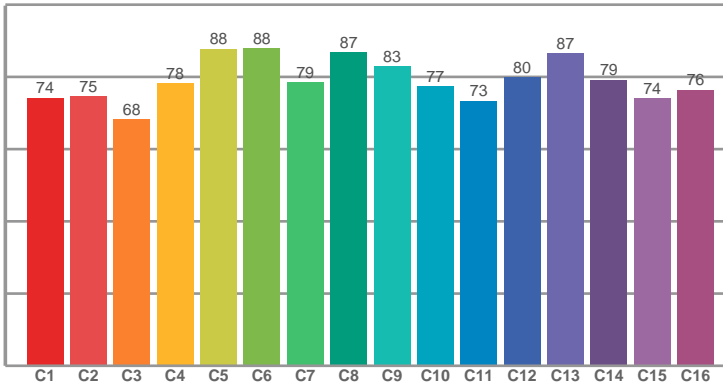

CRI R values, only R1-R8 are used to calculate final CRI value

R1	R2	R3	R4	R5	R6	R7	R8	R9	R10	R11	R12	R13	R14	R15
74.93	84.70	93.79	76.42	73.85	79.45	83.36	55.72	-5.69	64.46	73.11	57.98	76.59	96.11	67.02

TM30 C values, 16 binned values out of total of 99 C values

C1	C2	C3	C4	C5	C6	C7	C8	C9	C10	C11	C12	C13	C14	C15	C16
74.21	74.62	68.17	78.28	87.73	87.89	78.51	86.87	82.99	77.39	73.36	79.87	86.51	79.16	73.94	76.39

CQS Q values

Q1	Q2	Q3	Q4	Q5	Q6	Q7	Q8	Q9	Q10	Q11	Q12	Q13	Q14	Q15
65.28	94.96	74.73	65.60	70.47	74.94	78.64	86.66	93.36	90.54	84.27	82.64	80.89	64.39	64.03

CQS: 75.6

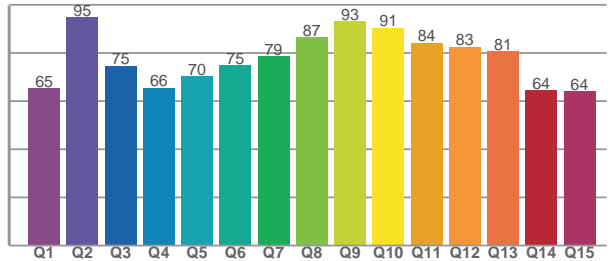

Color parameters

CCT	CRI	CRI R9	TM30 Rf	TM30 Rg	CQS	x	y	u	v	Duv
2989 K	77.8	-5.7	78.8	95.6	75.6	0.4	0.4	0.2	0.4	0.0032

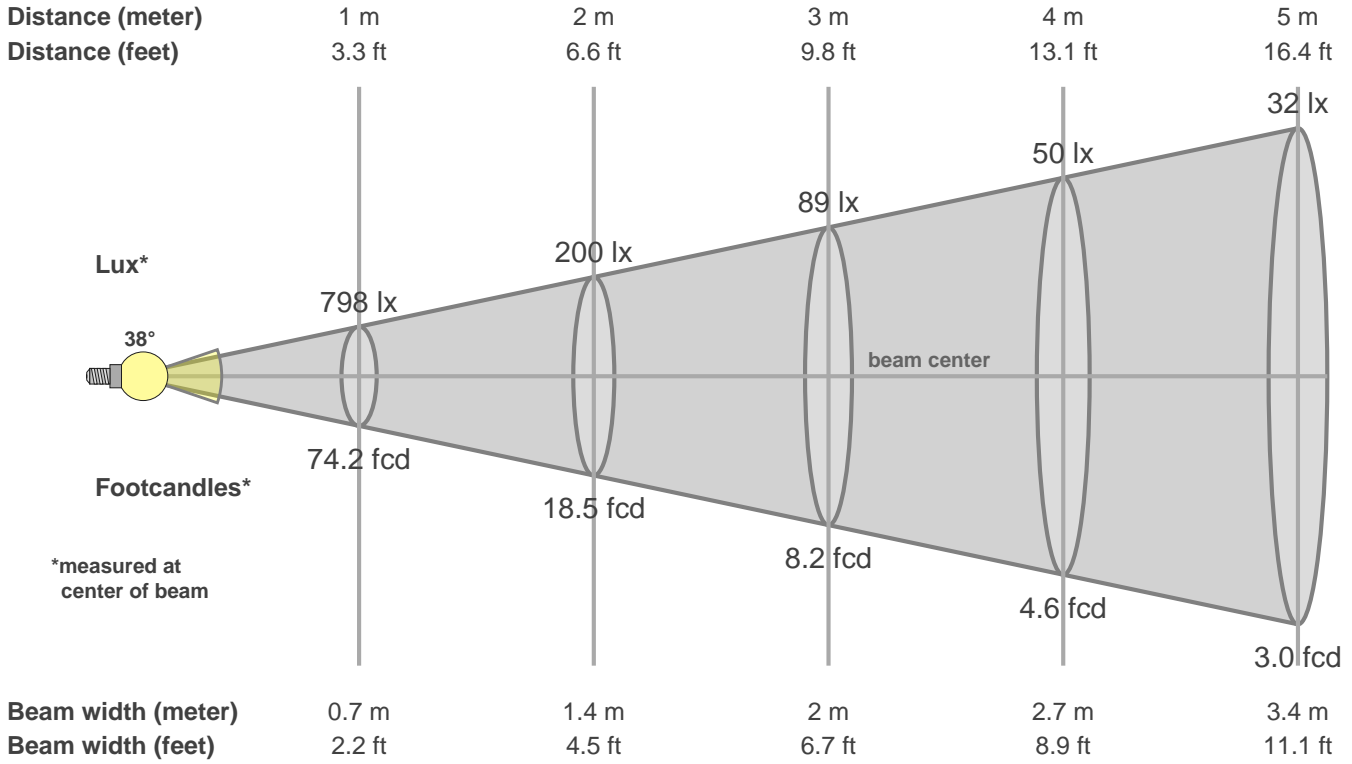

Intensities in 0° c-plane

0°	2°	4°	6°	8°	10°	12°	14°	16°	18°	20°	22°	24°	26°	28°	30°	32°	34°	36°	38°
798	786	747	685	610	527	442	361	287	227	176	136	105	81	65	52	42	35	29	25
100%	98%	94%	86%	76%	66%	55%	45%	36%	28%	22%	17%	13%	10%	8%	7%	5%	4%	4%	3%

Intensities in 90° c-plane

0°	2°	4°	6°	8°	10°	12°	14°	16°	18°	20°	22°	24°	26°	28°	30°	32°	34°	36°	38°
798	794	788	777	761	742	720	691	661	626	589	550	507	464	418	375	331	291	251	215
100%	99%	99%	97%	95%	93%	90%	87%	83%	78%	74%	69%	64%	58%	52%	47%	42%	36%	31%	27%

Intensities in 180° c-plane

0°	2°	4°	6°	8°	10°	12°	14°	16°	18°	20°	22°	24°	26°	28°	30°	32°	34°	36°	38°
798	786	747	685	610	527	442	361	287	227	176	136	105	81	65	52	42	35	29	25
100%	98%	94%	86%	76%	66%	55%	45%	36%	28%	22%	17%	13%	10%	8%	7%	5%	4%	4%	3%

Intensities in 270° c-plane

0°	2°	4°	6°	8°	10°	12°	14°	16°	18°	20°	22°	24°	26°	28°	30°	32°	34°	36°	38°
798	794	788	777	761	742	720	691	661	626	589	550	507	464	418	375	331	291	251	215
100%	99%	99%	97%	95%	93%	90%	87%	83%	78%	74%	69%	64%	58%	52%	47%	42%	36%	31%	27%

Beam angle 50%	Field angle 10%	Cutoff angle 2.5%	Intensity ratio in 120° cone	Intensity ratio in 90° cone
37.5°	69.6°	99.6°	93.0%	86.2%