

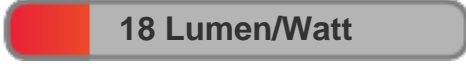

Light efficiency:



Light quality:



Color temperature:



Output: 251 lm

Peak: 662 cd

Power: 13.9 W

48.2V @ 0.289A

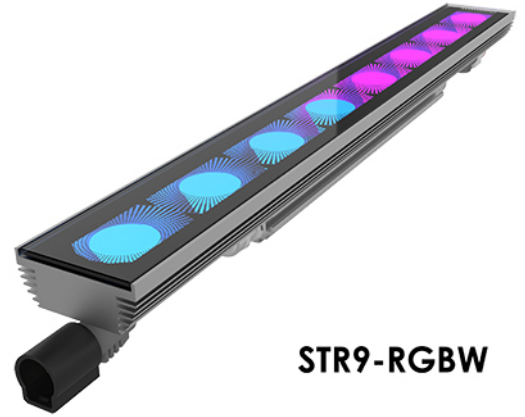

STR9-RGBW

Beam angle

29.7°

(6 PLANES)
12 C-Planes

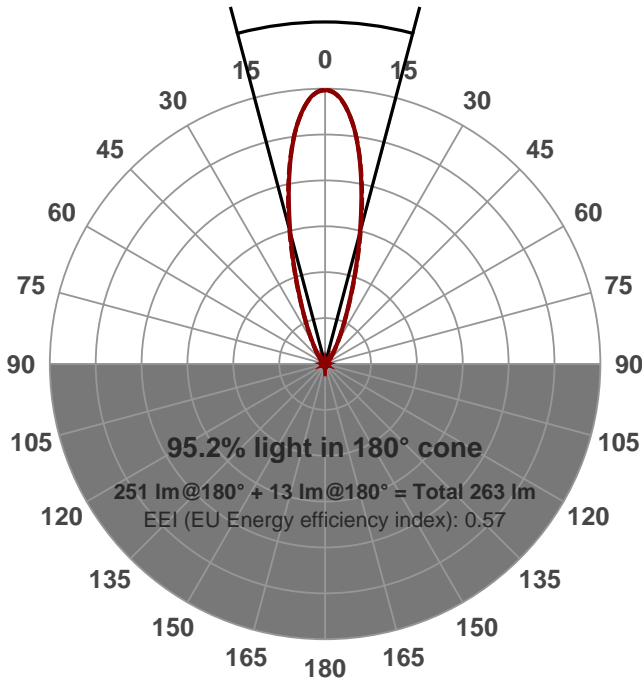

Product name:

STR9-300-CM-20W-RGBW-30-ELV-RED

Date and time:

2016-09-20 12:24:30 PM

Additional information:

FILM: 250162

LED: RGBW (3000K)

FIXTURE: 1FT MODULE

NORMALIZED: YES

PERFORMED BY: NH

Color



CIE1931
x: 0.694
y: 0.295

Spectra

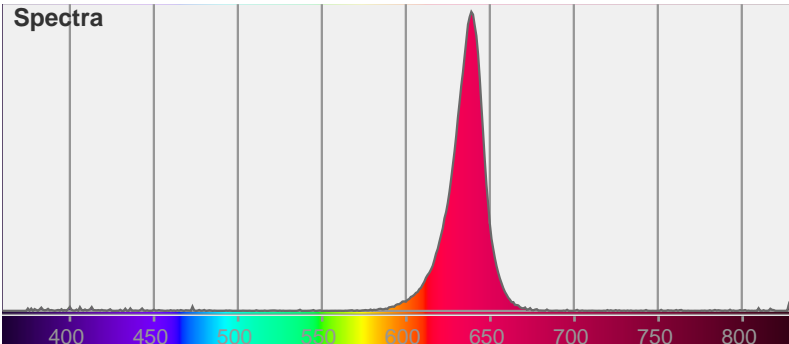

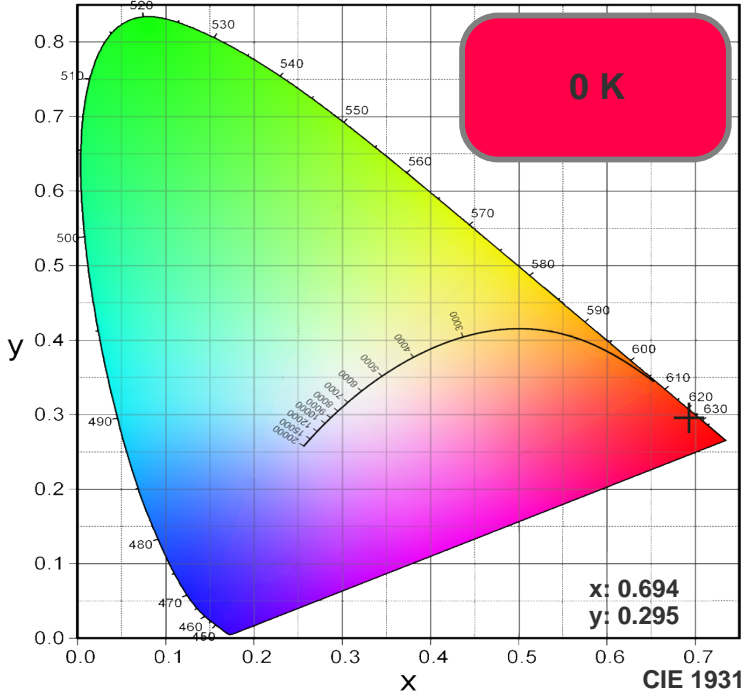

TM30: 0.0

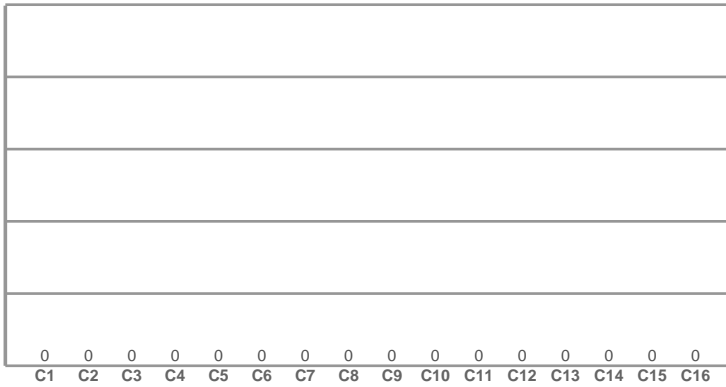

CRI R values, only R1-R8 are used to calculate final CRI value

R1	R2	R3	R4	R5	R6	R7	R8	R9	R10	R11	R12	R13	R14	R15
0.00	0.00	0.00	0.00	0.00	0.00	0.00	0.00	0.00	0.00	0.00	0.00	0.00	0.00	0.00

TM30 C values, 16 binned values out of total of 99 C values

C1	C2	C3	C4	C5	C6	C7	C8	C9	C10	C11	C12	C13	C14	C15	C16
0.00	0.00	0.00	0.00	0.00	0.00	0.00	0.00	0.00	0.00	0.00	0.00	0.00	0.00	0.00	0.00

CQS Q values

Q1	Q2	Q3	Q4	Q5	Q6	Q7	Q8	Q9	Q10	Q11	Q12	Q13	Q14	Q15
0.00	0.00	0.00	0.00	0.00	0.00	0.00	0.00	0.00	0.00	0.00	0.00	0.00	0.00	0.00

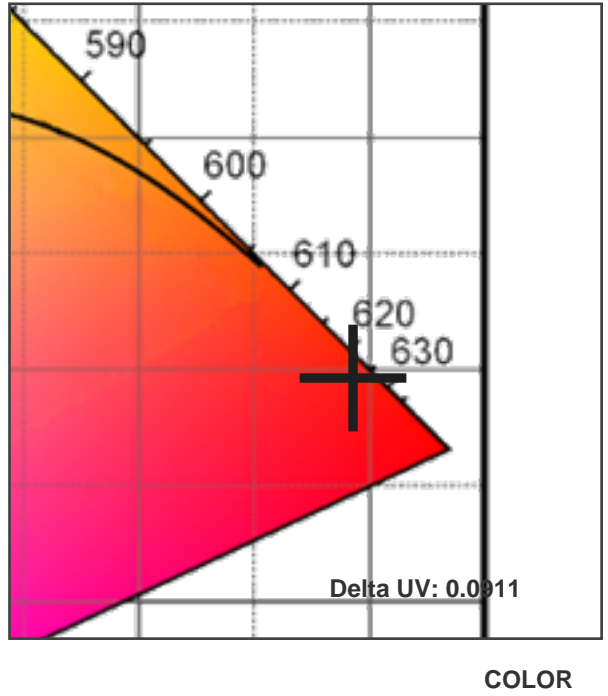

CRI: 0.0 (R1-R8)

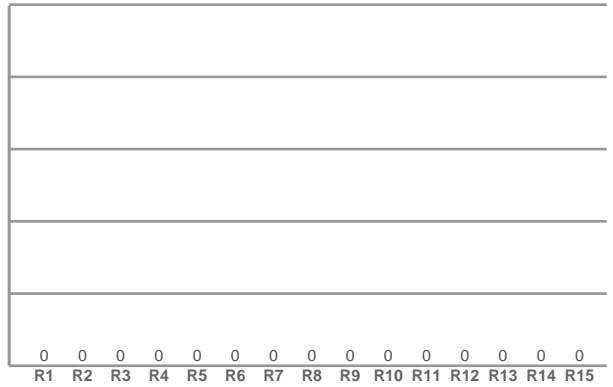

CQS: 0.0

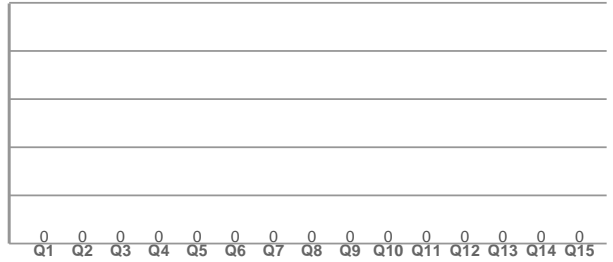

Color parameters

CCT	CRI	CRI R9	TM30 Rf	TM30 Rg	CQS	x	y	u	v	Duv
0 K	0.0	0.0	0.0	0.0	0.0	0.7	0.3	0.5	0.3	0.0000

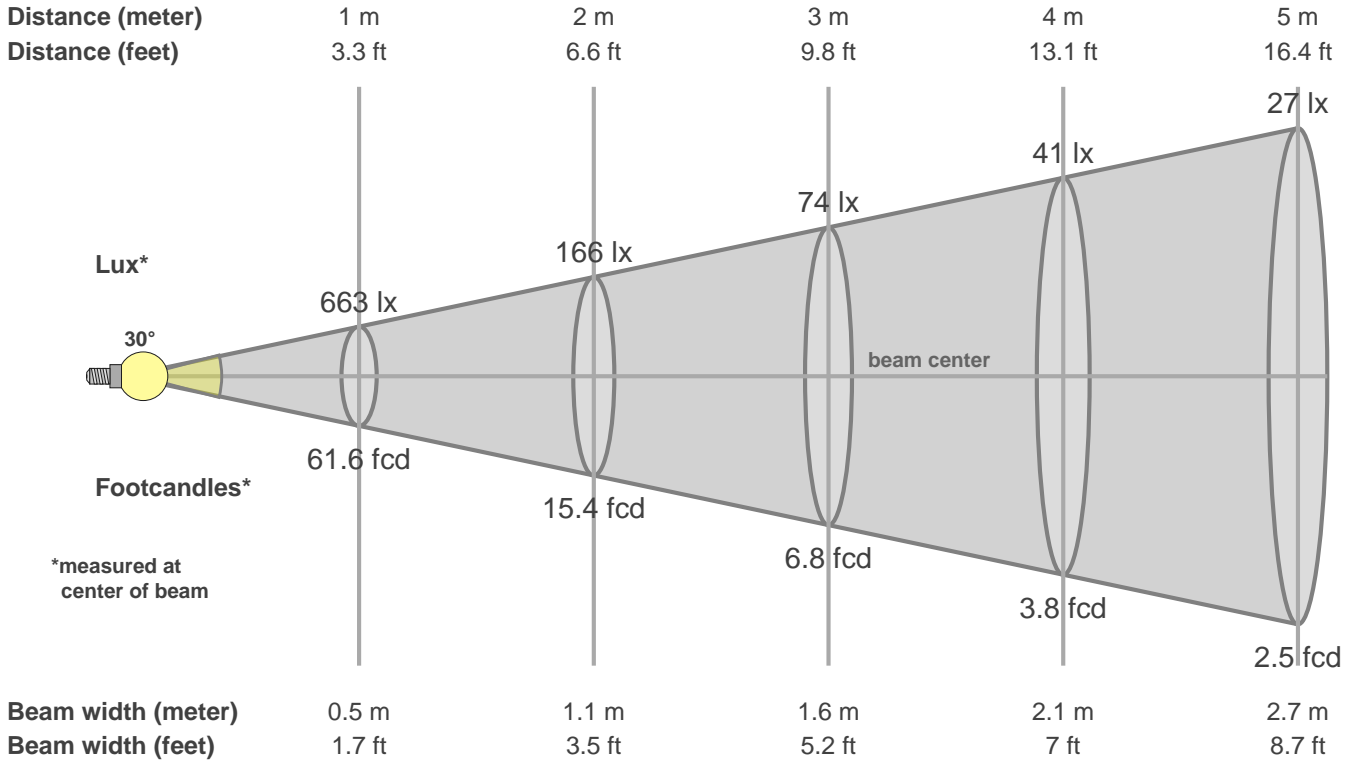

Intensities in 0° c-plane

0°	2°	4°	6°	8°	10°	12°	14°	16°	18°	20°	22°	24°	26°	28°	30°	32°	34°	36°	38°
663	655	633	596	548	489	423	355	294	237	189	150	119	96	77	61	49	40	33	28
100%	99%	96%	90%	83%	74%	64%	54%	44%	36%	28%	23%	18%	14%	12%	9%	7%	6%	5%	4%

Intensities in 90° c-plane

0°	2°	4°	6°	8°	10°	12°	14°	16°	18°	20°	22°	24°	26°	28°	30°	32°	34°	36°	38°
663	655	632	597	549	492	428	364	300	242	194	152	121	96	77	63	50	42	35	29
100%	99%	95%	90%	83%	74%	65%	55%	45%	37%	29%	23%	18%	14%	12%	10%	8%	6%	5%	4%

Intensities in 180° c-plane

0°	2°	4°	6°	8°	10°	12°	14°	16°	18°	20°	22°	24°	26°	28°	30°	32°	34°	36°	38°
663	655	633	596	548	489	423	355	294	237	189	150	119	96	77	61	49	40	33	28
100%	99%	96%	90%	83%	74%	64%	54%	44%	36%	28%	23%	18%	14%	12%	9%	7%	6%	5%	4%

Intensities in 270° c-plane

0°	2°	4°	6°	8°	10°	12°	14°	16°	18°	20°	22°	24°	26°	28°	30°	32°	34°	36°	38°
663	655	632	597	549	492	428	364	300	242	194	152	121	96	77	63	50	42	35	29
100%	99%	95%	90%	83%	74%	65%	55%	45%	37%	29%	23%	18%	14%	12%	10%	8%	6%	5%	4%

Beam angle 50%	Field angle 10%	Cutoff angle 2.5%	Intensity ratio in 120° cone	Intensity ratio in 90° cone
29.7°	58.7°	88.1°	90.7%	85.5%