

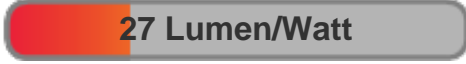

Light efficiency:



Light quality:



Color temperature:

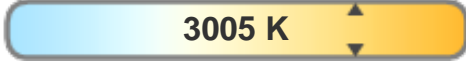

Output: 443 lm
Peak: 1202 cd
Power: 16.5 W
48.2V @ 0.342A

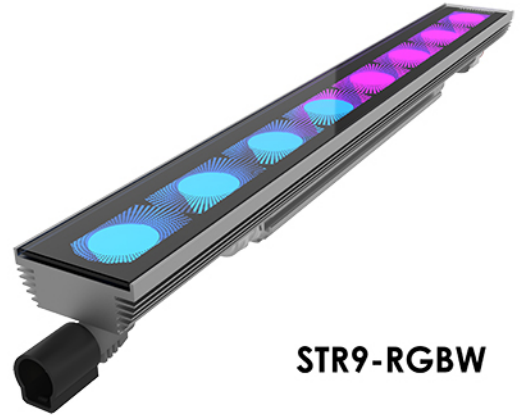

STR9-RGBW

Beam angle

29.7°

(6 PLANES)
12 C-Planes

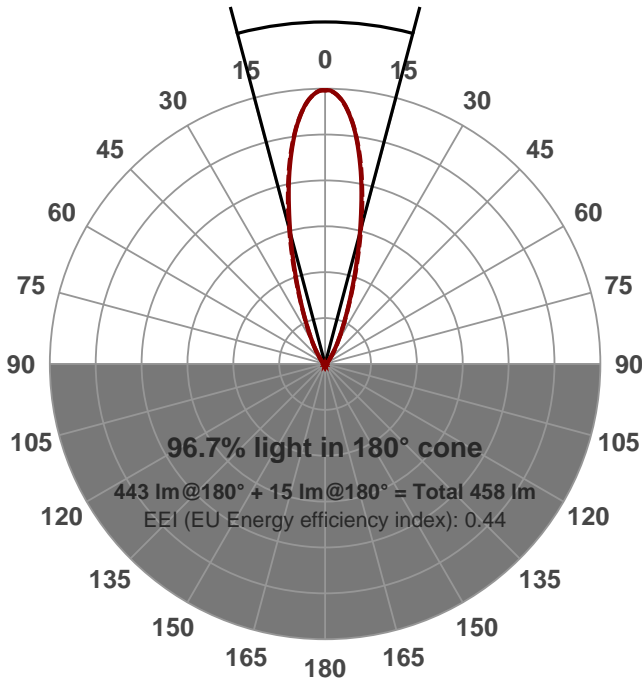

Product name:

STR9-300-CM-20W-RGBW-30-ELV-WHITE

Date and time:

2016-09-20 11:55:49 AM

Additional information:

FILM: 250162

LED: RGBW (3000K)

FIXTURE: 1FT MODULE

NORMALIZED: YES

PERFORMED BY: NH

Color



CIE1931
x: 0.441
y: 0.412

Spectra

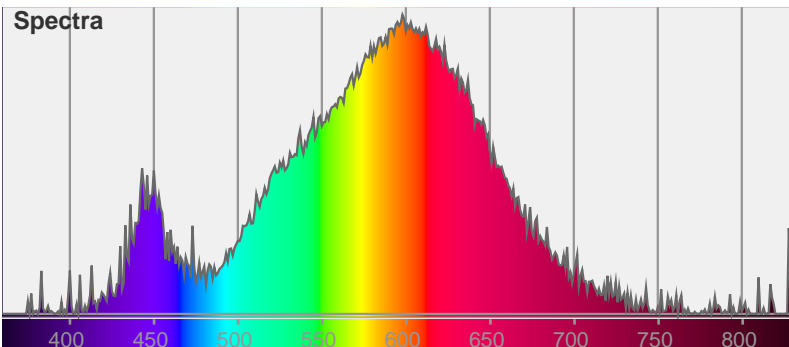

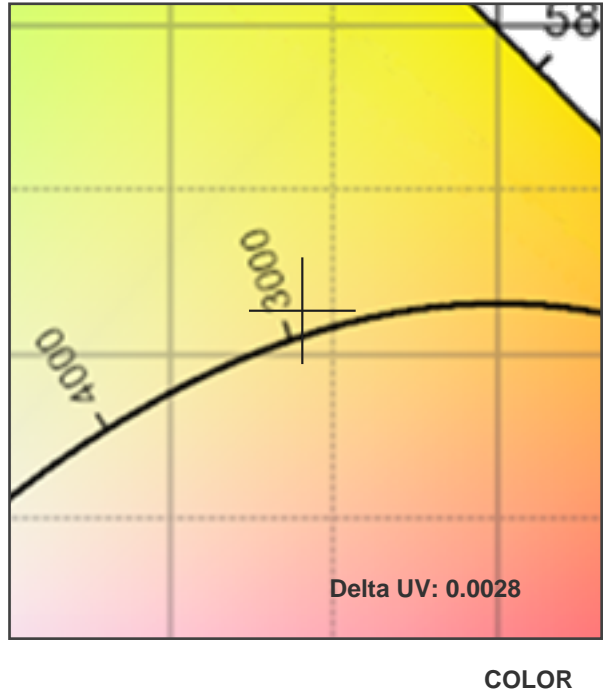
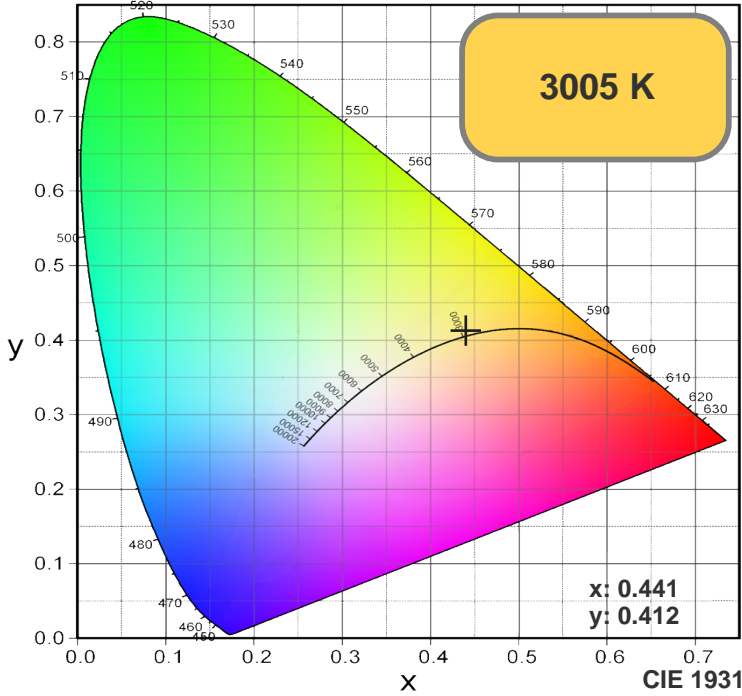

TM30: 79.0

CRI: 78.2 (R1-R8)

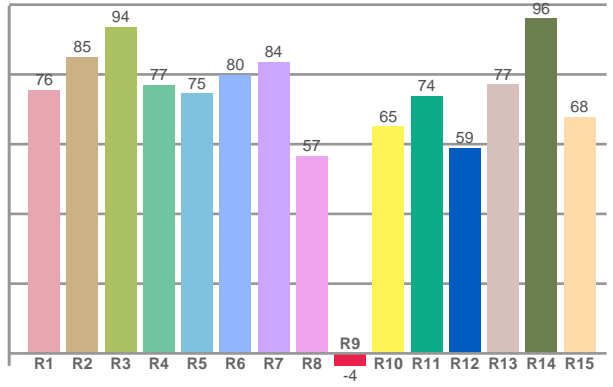
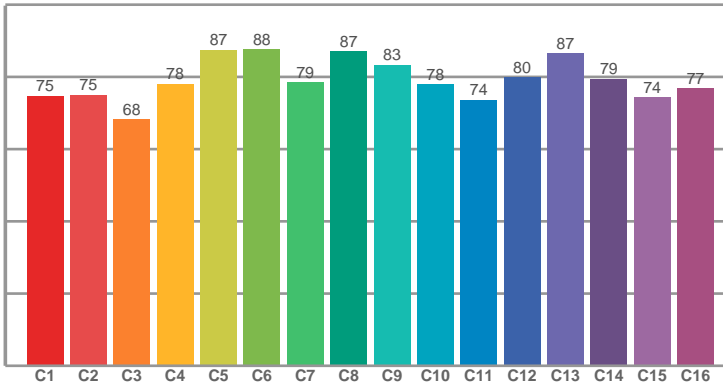

CRI R values, only R1-R8 are used to calculate final CRI value

R1	R2	R3	R4	R5	R6	R7	R8	R9	R10	R11	R12	R13	R14	R15
75.56	85.04	93.71	77.00	74.52	79.90	83.55	56.63	-3.55	65.16	73.86	59.01	77.18	96.07	67.84

TM30 C values, 16 binned values out of total of 99 C values

C1	C2	C3	C4	C5	C6	C7	C8	C9	C10	C11	C12	C13	C14	C15	C16
74.74	75.01	68.28	78.05	87.49	87.55	78.52	86.99	83.29	77.83	73.60	79.86	86.54	79.45	74.30	76.75

CQS Q values

Q1	Q2	Q3	Q4	Q5	Q6	Q7	Q8	Q9	Q10	Q11	Q12	Q13	Q14	Q15
67.10	95.33	75.33	67.56	72.80	76.63	79.81	87.04	95.12	90.84	85.30	83.65	81.92	65.77	65.71

CQS: 76.9

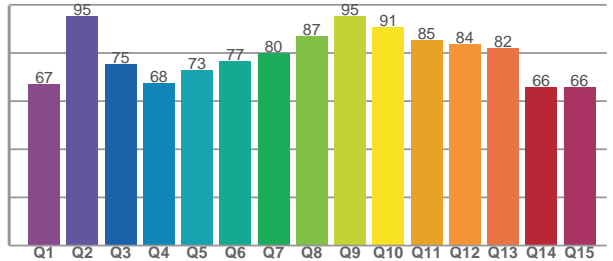

Color parameters

CCT	CRI	CRI R9	TM30 Rf	TM30 Rg	CQS	x	y	u	v	Duv
3005 K	78.2	-3.6	79.0	96.0	76.9	0.4	0.4	0.2	0.4	0.0028

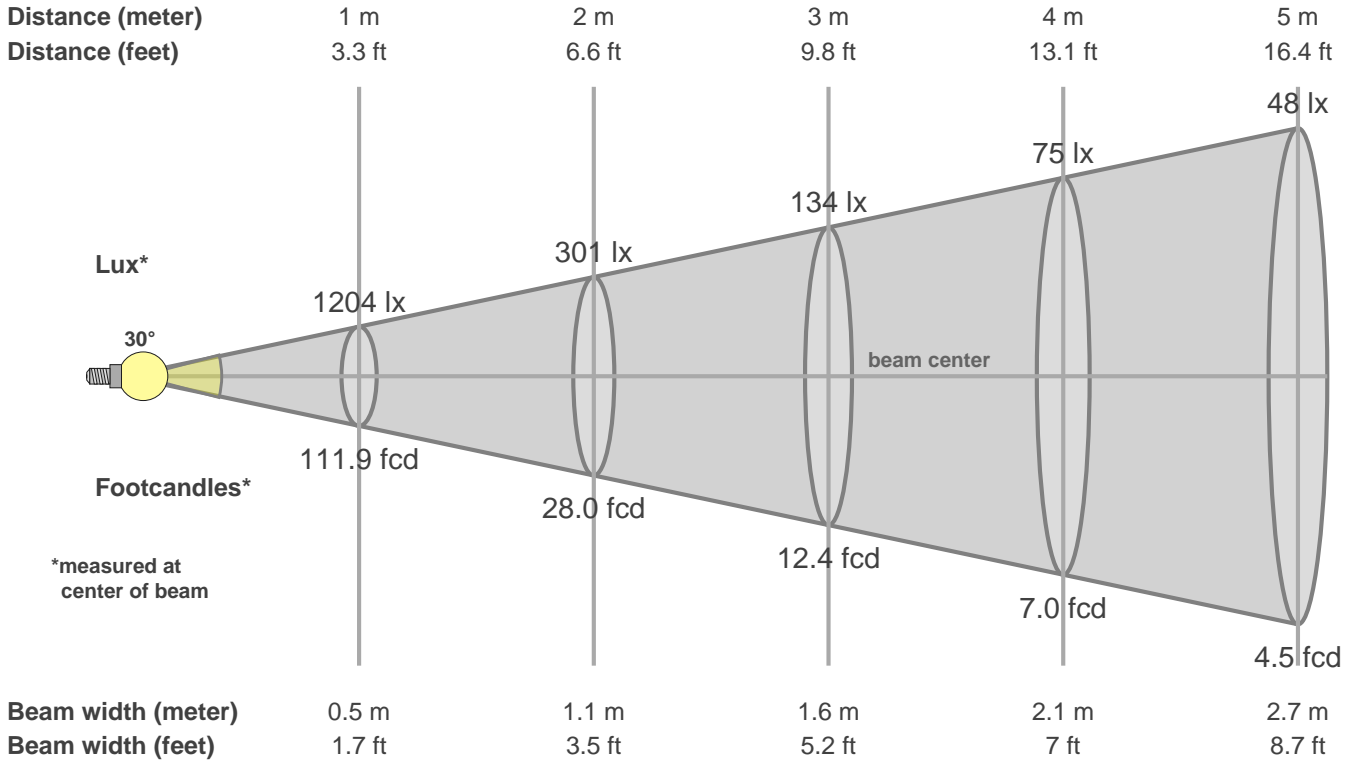

Intensities in 0° c-plane

0°	2°	4°	6°	8°	10°	12°	14°	16°	18°	20°	22°	24°	26°	28°	30°	32°	34°	36°	38°
1204	1190	1151	1083	994	887	768	646	534	430	342	272	215	171	138	111	88	72	58	48
100%	99%	96%	90%	83%	74%	64%	54%	44%	36%	28%	23%	18%	14%	11%	9%	7%	6%	5%	4%

Intensities in 90° c-plane

0°	2°	4°	6°	8°	10°	12°	14°	16°	18°	20°	22°	24°	26°	28°	30°	32°	34°	36°	38°
1204	1190	1149	1085	999	897	782	663	549	444	352	278	220	174	140	113	92	75	60	50
100%	99%	95%	90%	83%	75%	65%	55%	46%	37%	29%	23%	18%	14%	12%	9%	8%	6%	5%	4%

Intensities in 180° c-plane

0°	2°	4°	6°	8°	10°	12°	14°	16°	18°	20°	22°	24°	26°	28°	30°	32°	34°	36°	38°
1204	1190	1151	1083	994	887	768	646	534	430	342	272	215	171	138	111	88	72	58	48
100%	99%	96%	90%	83%	74%	64%	54%	44%	36%	28%	23%	18%	14%	11%	9%	7%	6%	5%	4%

Intensities in 270° c-plane

0°	2°	4°	6°	8°	10°	12°	14°	16°	18°	20°	22°	24°	26°	28°	30°	32°	34°	36°	38°
1204	1190	1149	1085	999	897	782	663	549	444	352	278	220	174	140	113	92	75	60	50
100%	99%	95%	90%	83%	75%	65%	55%	46%	37%	29%	23%	18%	14%	12%	9%	8%	6%	5%	4%

Beam angle 50%	Field angle 10%	Cutoff angle 2.5%	Intensity ratio in 120° cone	Intensity ratio in 90° cone
29.7°	58.5°	86.3°	93.5%	88.9%