

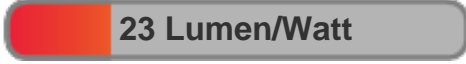

Light efficiency:



Light quality:



Color temperature:



Output: 423 lm
Peak: 258 cd
Power: 18.3 W
48.2V @ 0.381A

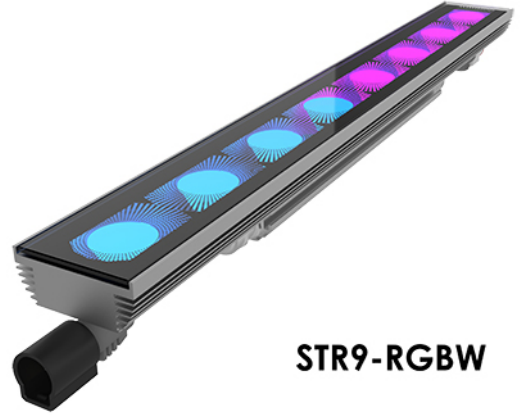

STR9-RGBW

Beam angle

78.7°

(6 PLANES)
12 C-Planes

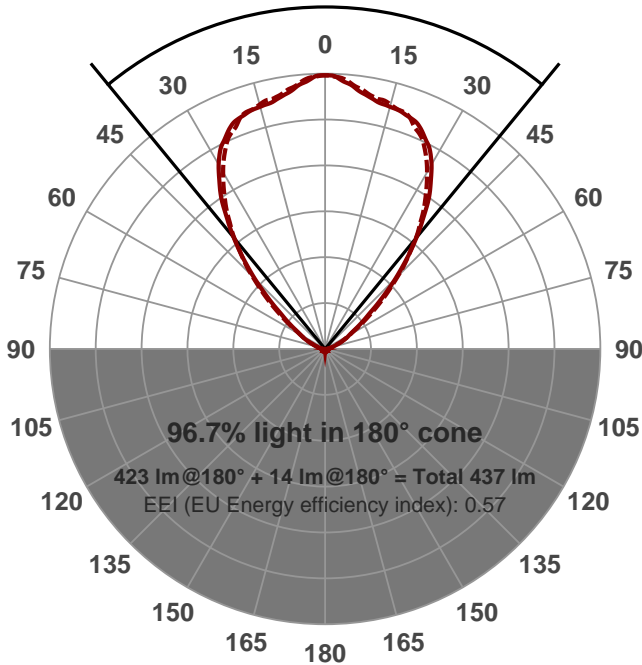

Product name:

STR9-300-CM-20W-RGBW-80-ELV-GREEN

Date and time:

2016-09-21 11:10:25 AM

Additional information:

FILM: 250164

LED: RGBW (3000K)

FIXTURE: 1FT MODULE

NORMALIZED: YES

PERFORMED BY: NH

Color



CIE1931
x: 0.168
y: 0.686

Spectra

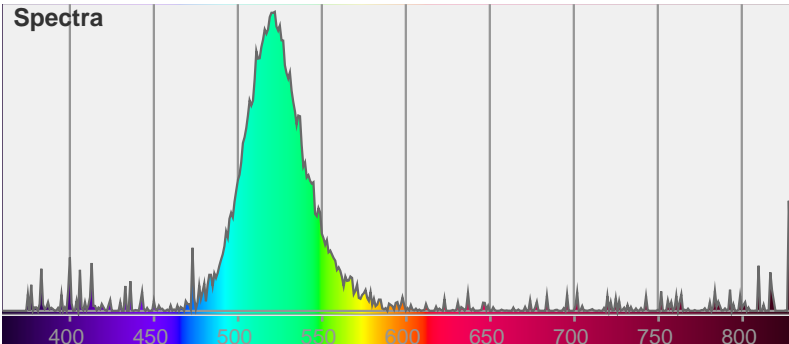

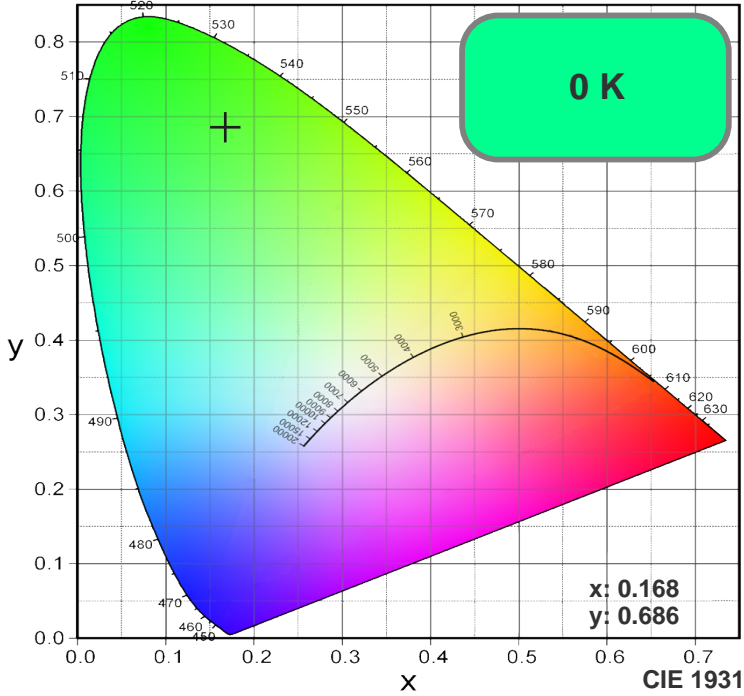

TM30: 0.0

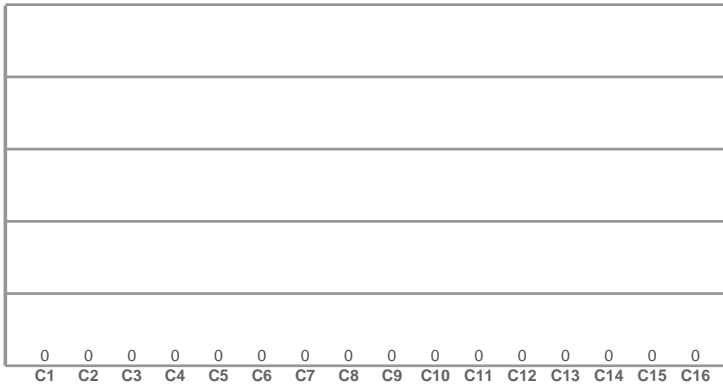

CRI R values, only R1-R8 are used to calculate final CRI value

0.00	0.00	0.00	0.00	0.00	0.00	0.00	0.00	0.00	0.00	0.00	0.00	0.00	0.00	0.00
R1	R2	R3	R4	R5	R6	R7	R8	R9	R10	R11	R12	R13	R14	R15

TM30 C values, 16 binned values out of total of 99 C values

0.00	0.00	0.00	0.00	0.00	0.00	0.00	0.00	0.00	0.00	0.00	0.00	0.00	0.00	0.00	0.00
C1	C2	C3	C4	C5	C6	C7	C8	C9	C10	C11	C12	C13	C14	C15	C16

CQS Q values

0.00	0.00	0.00	0.00	0.00	0.00	0.00	0.00	0.00	0.00	0.00	0.00	0.00	0.00	0.00
Q1	Q2	Q3	Q4	Q5	Q6	Q7	Q8	Q9	Q10	Q11	Q12	Q13	Q14	Q15

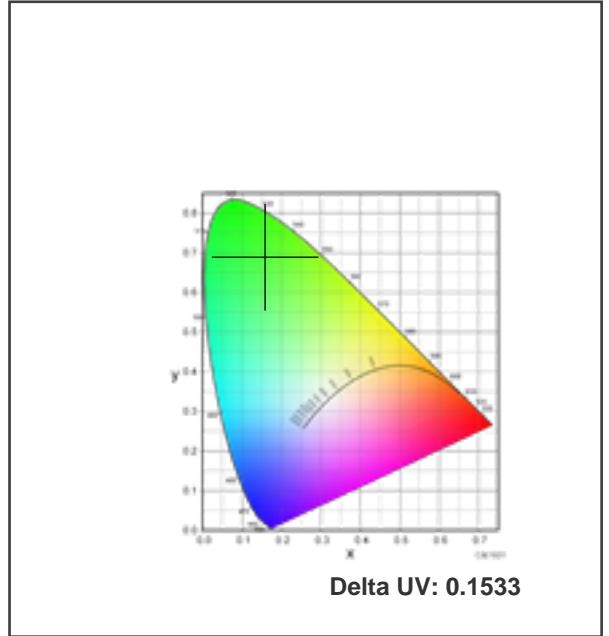

COLOR

CRI: 0.0 (R1-R8)

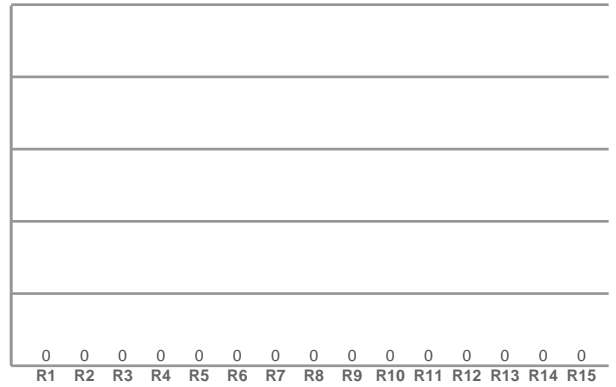

CQS: 0.0

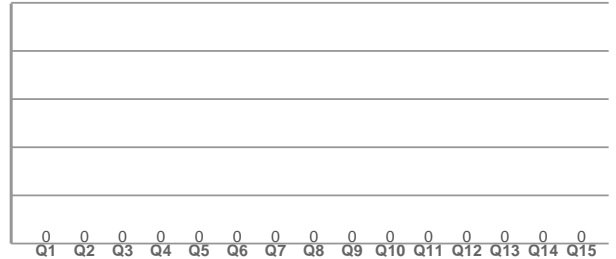

Color parameters

CCT	CRI	CRI R9	TM30 Rf	TM30 Rg	CQS	x	y	u	v	Duv
0 K	0.0	0.0	0.0	0.0	0.0	0.2	0.7	0.1	0.4	0.0000

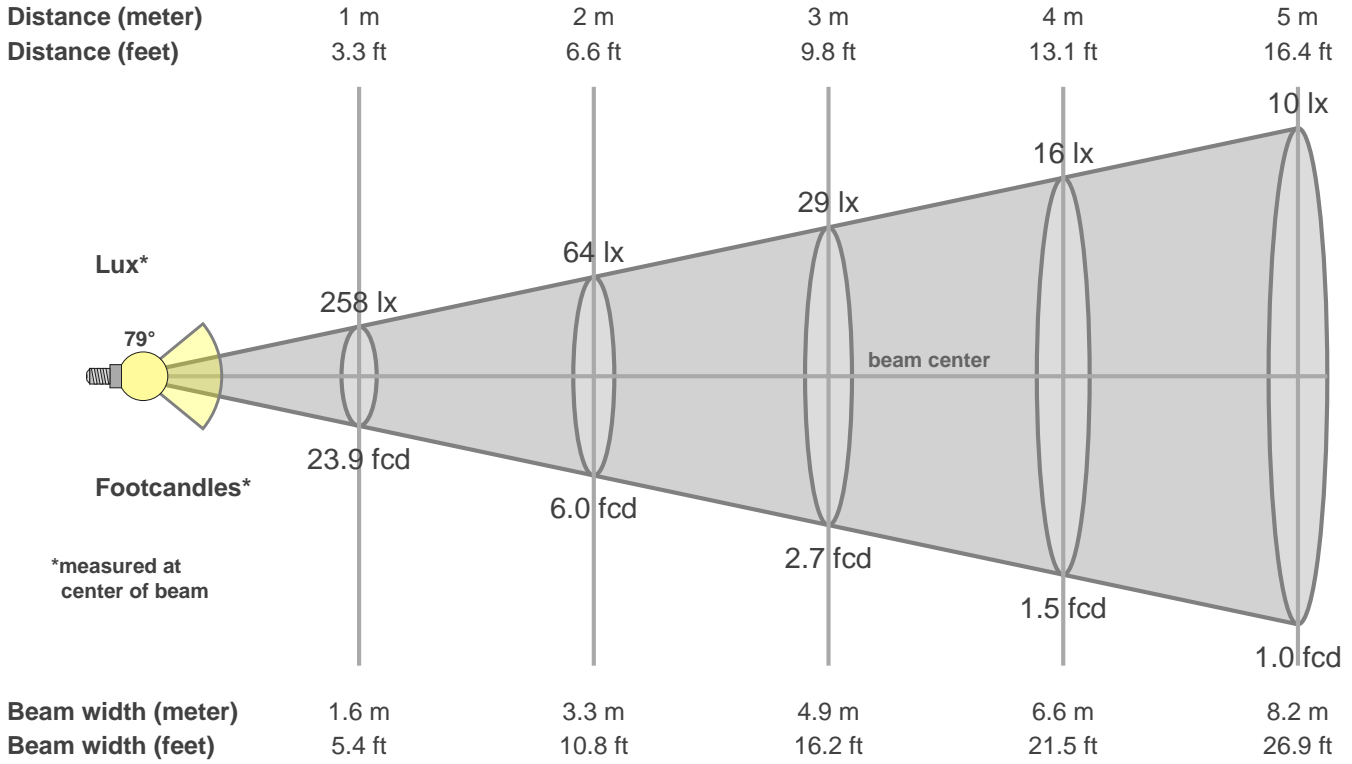

Intensities in 0° c-plane

0°	5°	10°	15°	20°	25°	30°	35°	40°	45°	50°	55°	60°	65°	70°	75°	80°	85°	90°	95°
258	250	240	236	232	221	200	169	131	94	61	40	27	19	11	7	4	3	2	0
100%	97%	93%	91%	90%	86%	78%	65%	51%	36%	24%	15%	10%	7%	4%	3%	2%	1%	1%	0%

Intensities in 90° c-plane

0°	5°	10°	15°	20°	25°	30°	35°	40°	45°	50°	55°	60°	65°	70°	75°	80°	85°	90°	95°
258	252	242	238	232	217	192	162	129	97	67	43	27	18	12	7	5	3	2	0
100%	98%	94%	92%	90%	84%	74%	63%	50%	38%	26%	17%	11%	7%	5%	3%	2%	1%	1%	0%

Intensities in 180° c-plane

0°	5°	10°	15°	20°	25°	30°	35°	40°	45°	50°	55°	60°	65°	70°	75°	80°	85°	90°	95°
258	250	240	236	232	221	200	169	131	94	61	40	27	19	11	7	4	3	2	0
100%	97%	93%	91%	90%	86%	78%	65%	51%	36%	24%	15%	10%	7%	4%	3%	2%	1%	1%	0%

Intensities in 270° c-plane

0°	5°	10°	15°	20°	25°	30°	35°	40°	45°	50°	55°	60°	65°	70°	75°	80°	85°	90°	95°
258	252	242	238	232	217	192	162	129	97	67	43	27	18	12	7	5	3	2	0
100%	98%	94%	92%	90%	84%	74%	63%	50%	38%	26%	17%	11%	7%	5%	3%	2%	1%	1%	0%

Beam angle 50%	Field angle 10%	Cutoff angle 2.5%	Intensity ratio in 120° cone	Intensity ratio in 90° cone
78.7°	119.9°	152.6°	90.1%	75.0%