

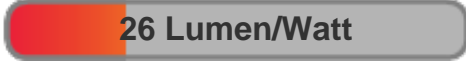

Light efficiency:



Light quality:



Color temperature:

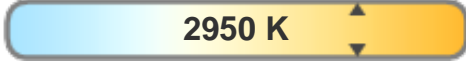

Output: 435 lm  
Peak: 274 cd  
Power: 16.4 W  
48.2V @ 0.341A

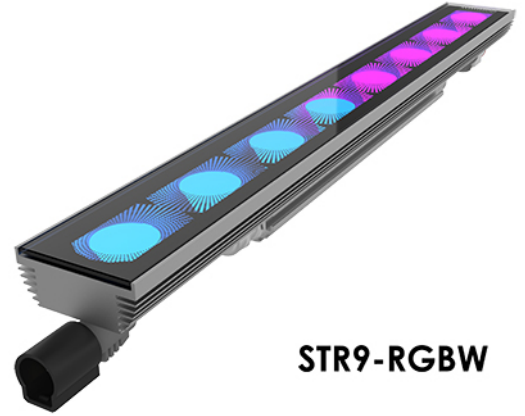

STR9-RGBW

Beam angle

77.8°

(6 PLANES)  
12 C-Planes

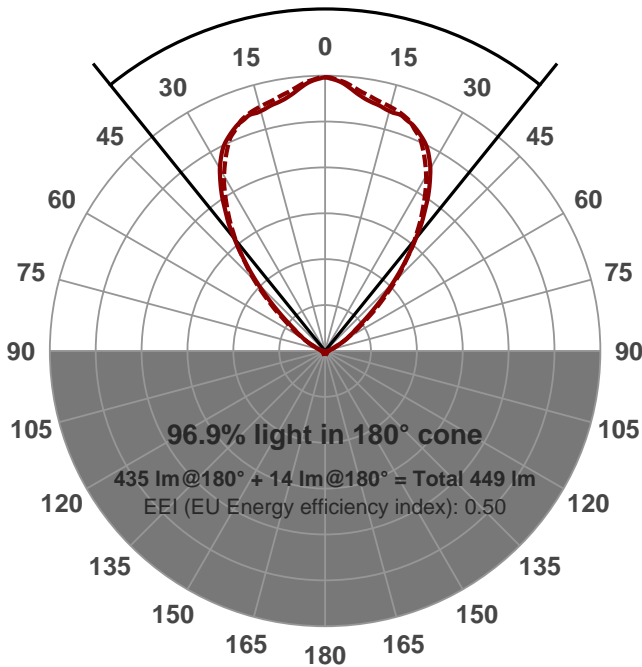

Product name:

STR9-300-CM-20W-RGBW-80-ELV-WHITE

Date and time:

2016-09-21 1:38:38 PM

Additional information:

FILM: 250164

LED: RGBW (3000K)

FIXTURE: 1FT MODULE

NORMALIZED: YES

PERFORMED BY: NH

Color



CIE1931  
x: 0.447  
y: 0.419

Spectra

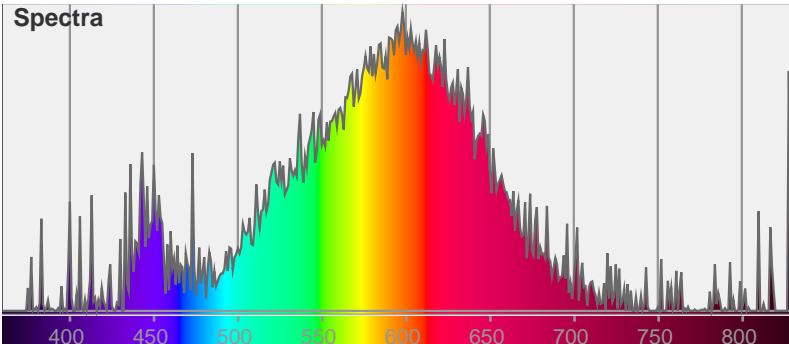

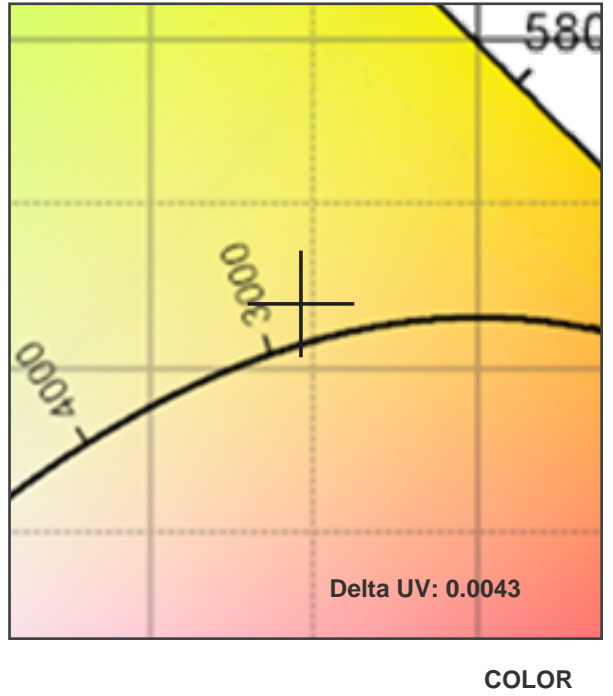
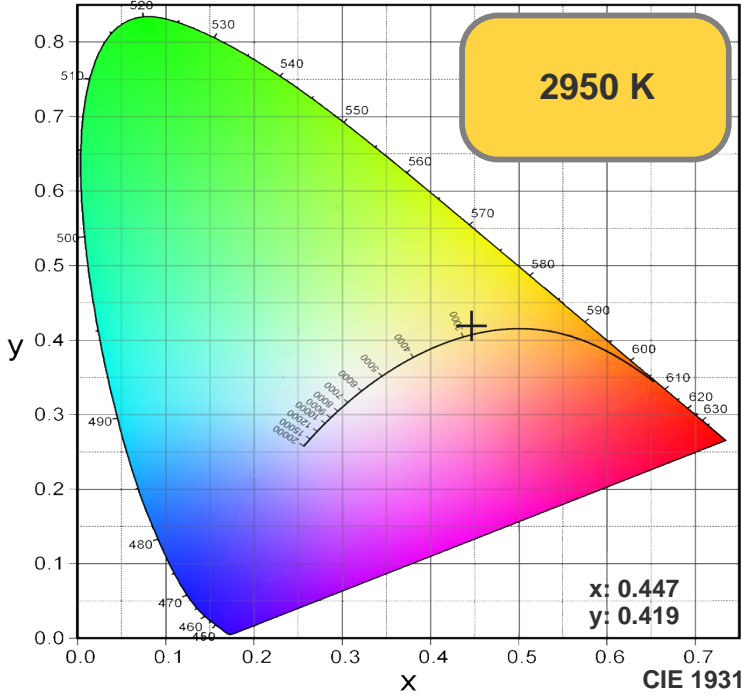

TM30: 78.6

CRI: 76.7 (R1-R8)

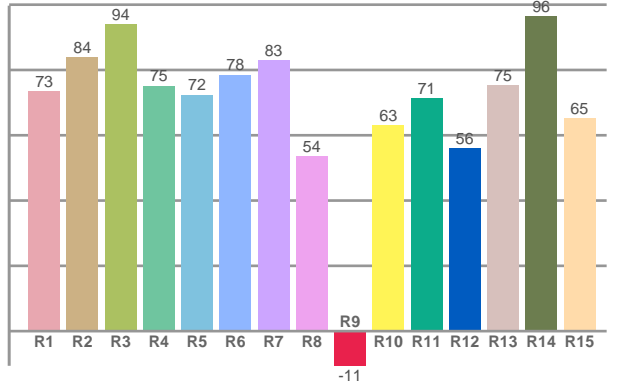
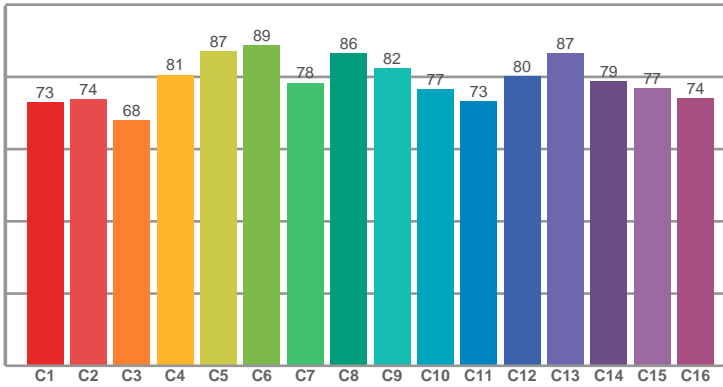

CRI R values, only R1-R8 are used to calculate final CRI value

R1	R2	R3	R4	R5	R6	R7	R8	R9	R10	R11	R12	R13	R14	R15
73.48	83.94	94.06	75.07	72.31	78.48	82.90	53.60	-10.62	62.92	71.29	56.01	75.22	96.27	65.11

TM30 C values, 16 binned values out of total of 99 C values

C1	C2	C3	C4	C5	C6	C7	C8	C9	C10	C11	C12	C13	C14	C15	C16
72.96	73.70	67.97	80.56	86.98	88.75	78.36	86.44	82.29	76.55	73.21	80.12	86.55	78.76	76.80	74.09

CQS Q values

Q1	Q2	Q3	Q4	Q5	Q6	Q7	Q8	Q9	Q10	Q11	Q12	Q13	Q14	Q15
60.66	93.93	73.55	61.13	64.07	69.68	74.44	83.07	86.01	84.84	79.84	78.41	77.07	60.54	59.52

CQS: 71.6

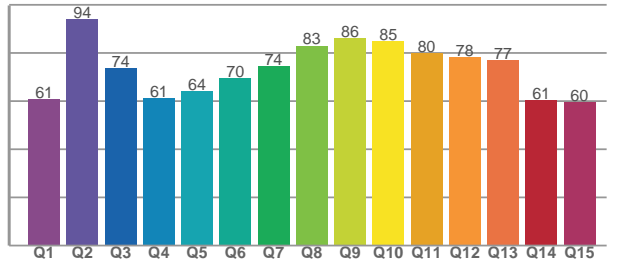

Color parameters

CCT	CRI	CRI R9	TM30 Rf	TM30 Rg	CQS	x	y	u	v	Duv
2950 K	76.7	-10.6	78.6	94.5	71.6	0.4	0.4	0.3	0.4	0.0043

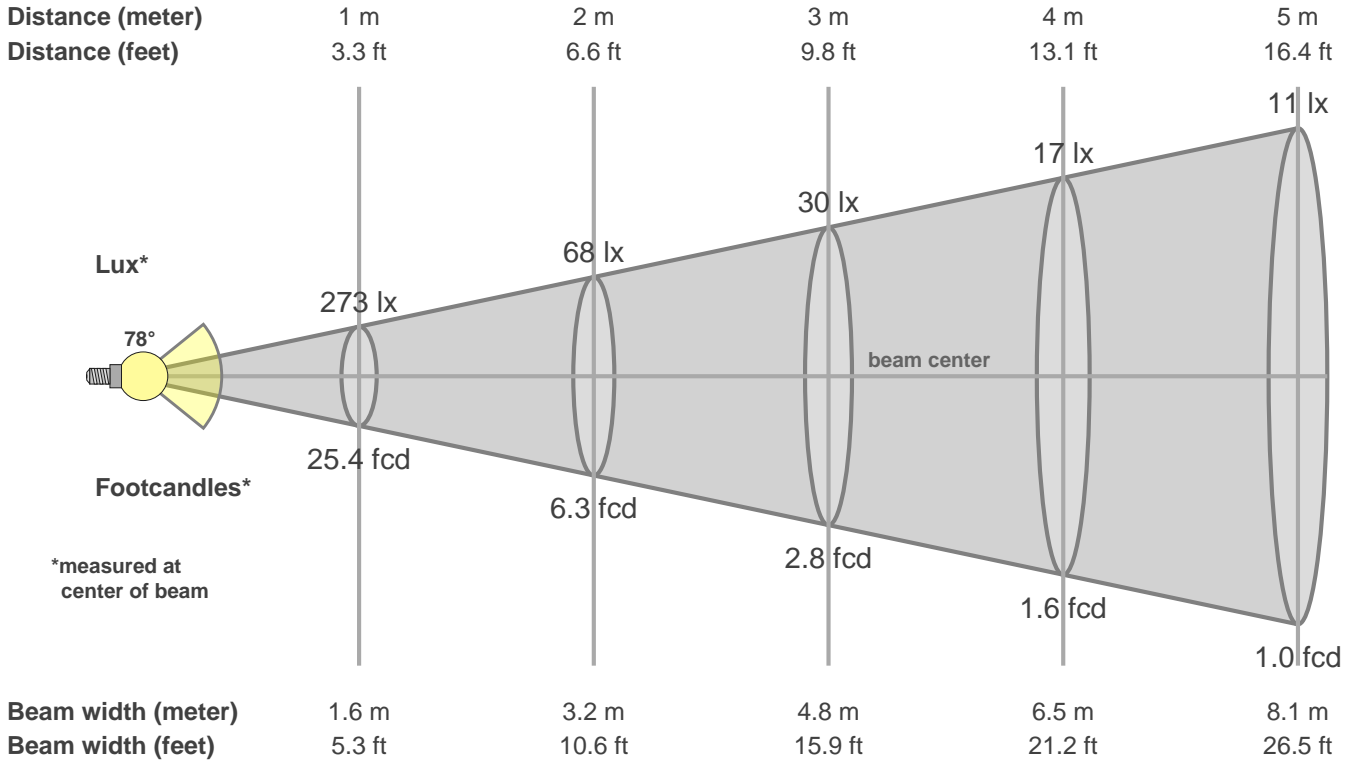

**Intensities in 0° c-plane**

0°	5°	10°	15°	20°	25°	30°	35°	40°	45°	50°	55°	60°	65°	70°	75°	80°	85°	90°	95°
273	265	254	248	244	233	210	175	135	95	60	37	25	16	10	6	4	3	2	0
100%	97%	93%	91%	89%	85%	77%	64%	49%	35%	22%	13%	9%	6%	4%	2%	1%	1%	1%	0%

**Intensities in 90° c-plane**

0°	5°	10°	15°	20°	25°	30°	35°	40°	45°	50°	55°	60°	65°	70°	75°	80°	85°	90°	95°
273	268	258	252	245	228	202	169	135	100	67	42	26	16	10	6	4	2	2	0
100%	98%	95%	92%	90%	83%	74%	62%	50%	37%	25%	15%	10%	6%	4%	2%	1%	1%	1%	0%

**Intensities in 180° c-plane**

0°	5°	10°	15°	20°	25°	30°	35°	40°	45°	50°	55°	60°	65°	70°	75°	80°	85°	90°	95°
273	265	254	248	244	233	210	175	135	95	60	37	25	16	10	6	4	3	2	0
100%	97%	93%	91%	89%	85%	77%	64%	49%	35%	22%	13%	9%	6%	4%	2%	1%	1%	1%	0%

**Intensities in 270° c-plane**

0°	5°	10°	15°	20°	25°	30°	35°	40°	45°	50°	55°	60°	65°	70°	75°	80°	85°	90°	95°
273	268	258	252	245	228	202	169	135	100	67	42	26	16	10	6	4	2	2	0
100%	98%	95%	92%	90%	83%	74%	62%	50%	37%	25%	15%	10%	6%	4%	2%	1%	1%	1%	0%

Beam angle 50%	Field angle 10%	Cutoff angle 2.5%	Intensity ratio in 120° cone	Intensity ratio in 90° cone
77.8°	117.1°	148.2°	91.2%	76.7%